



POPULAR COMMUNICATIONS

NOVEMBER 2003

Inside NORAD: Nationwide Monitoring At Your Fingertips!

- How To Add 16 Countries To Your Logbook
- Technology Showcase: Galaxy AM/SSB CB And K40's Trucker Antenna

How To Get The Cell Gear You Want! p.52



U.S. \$4.99 / Canada \$6.99



PLUS: Your Favorite Radios, Music Under The AM Band, And Radio Trouble In Costa Rica

our readers

speak out letters to the editor

Each month, we select representative reader letters for our "Our Readers Speak Out" column. We reserve the right to condense lengthy letters for space reasons and to edit to conform to style. All letters submitted must be signed and show a return mailing address or valid e-mail address. Upon request, we will withhold a sender's name if the letter is used in "Our Readers Speak Out." Address letters to: Harold Ort, N2RLL, SSB-596, Editor, Popular Communications, 25 Newbridge Road, Hicksville, NY 11801-2909, or send e-mail via the Internet to <popularcom@aol.com>.

Tropo Ducting: Blessing And Curse

Dear Editor:

I just read the Gordon West article on tropo ducting and absolutely agree it may be a benefit as well as a problem. During the '60s, we had a lot of tropo ducting where TV reception in our fringe area was a total wreck with distant stations overriding local stations. This interruption of fringe-area reception caused everyone to blame the hams!

It gets worse: TV viewers were encouraged to buy Winegard Company antenna boosters, including the notorious "Red Head" single-transistor antenna booster that was easily overdriven. Again, the hams got the blame.

Then came the FM radio station problem. Whole neighborhoods would lose TV reception as the booster went into solid regeneration and oscillation. The FM station got swamped with calls complaining about their regenerated signals reaching clear up into the TV UHF range. This got the hams off the hook.

Winegard had to recall the boosters, fixing the two-transistor and twin-nuvistor ones with filters. The famous "Red Head" booster was relegated to the compactor! Winegard finally had to pay a \$50 bounty to any TV technician who brought one in, plus refunding the customer!

Tropo conditions continue to bring complaints to hams who, like me, have nothing to do with it. The hams got blamed, even though they weren't home! So incoming tropo signals that override local signals can be both good and bad!

John Anderson, KØBKL

Using The RTL Button

Dear Editor:

I read with great interest your "Tuning In" column in the September issue of *Popular Communications* regarding Nextel's trade marking the words, "Push To Talk". Yeah, I agree it is probably the dumbest thing I have ever heard. Since a multinational mega-billion dollar company such as Nextel has very deep pockets to fight any legal battles, why don't we communications enthusiasts just give them their trade mark and use the other name for that button on the side of our HTs? What other name? This "other name" was invented by me in response to one particular operator on a local 2-meter repeater who was in the habit of regularly being "bitten by the alligator," or timing

out the repeater by yammering on for over three minutes at a stretch, thereby shutting off the repeater's transmitter.

Of course, it was taken in the good humor in which it was intended, but I suggested that this operator start making better use of the RTL button on his radio, or "Release To Listen" button. He had already figured out the push-to-talk part, it was the release-to-listen function he was having difficulty dealing with!

Scott Schultz, NØIU

Still In La La Land?

Dear Editor:

I'm writing in response to the letter entitled, "Living In La La Land" in the April 2003 issue of *Pop Comm*. I'm also old enough to remember when the 23 CB channels, and then the 40 CB channels, were on a well-run and regulated service with local Channel Masters policing each channel. I'm a licensed GMRS radio operator and occasionally use the 40 CB channels, and also monitor and participate on the 14 FRS channels.

While I have studied for my ham operator's license...I just can't seem to get the code due to severe problems reading, hearing, and interpreting the code.

Sometimes it seems that the same group of people are using different bands on subsequent days, which kind of squeezes out the newly licensed. I love that ham radio is a fraternity. What has changed are a few selfish people who were not using some of their assigned spectrum and are now crying foul because the FCC has decided to auction off unused or ignored portions of spectrum. Please grow up!

The Federal Communications Commission is a government entity that assigns portions of the spectrum *for use*. They knew that, no matter how easy they made it to get your first ticket, only a small percent of the two-way loving populace would ever be licensed hams. This is why we now have a license-free FRS as a "gateway" two-way radio experience.

Primarily, my spouse and I use the FRS in supermarkets or in shopping malls as a short-range communications tool. Forty-channel CB radio sometimes affords me a super QSO. Recently, even my spouse asked me, while I was "playing," why I wasn't using the CB radio. I replied that I can rarely hold a conversation without some knucklehead clowning around or switching to a foreign language. This leaves me out of the loop, all within five minutes of getting on the air! Whatever happened to the use of the English-only rule in the USA?

Anyway, I would freeband also, but my second CB radio is a legal 40-channel radio and not an "illegal" (but widely sold) 120-channel CB radio. I wonder if the FCC will continue to allow us to enjoy this 2-MHz of spectrum which we "found" to be a great place to practice "the hobby."

My feeling and opinion is to have the FCC legalize the upper and lower sidebands. As your own "On-The-Go" column has stated, multiple means of communications are very important in a post-9/11 world.

Nathaniel
Bronx, NY

The French Connection— DXing The French Africans

How To Add 16 Countries To Your Shortwave Logbook

by Gerry L. Dexter

The French have been frustrating Americans ever since Ben Franklin spent all that time at the court of Louis XVI trying to get the king to align his country with the colonies during the American Revolutionary War.

It's a huge leap from the serious situation Franklin faced to DXers today, confronted with cultural residue in the African possessions that belonged to France 40-plus years ago and the shaky status of the broadcasters in those countries now. But, still, France has to bear some blame, even though Paris was under great pressure to grant independence and get the heck out.

When independence day arrived these new countries weren't fully prepared for it and most of them ran into trouble almost immediately. In the beginning, practically every former possession had a shortwave station and most were well operated, running good quality equipment and following regular schedules. It was an everyday thing to cruise the 60-meter band and find a dozen or more French African broadcasters signing on at 0400, 0430, 0500, or 0600. But try that tonight and you'll be in for a very big dose of what the real DX world is like these days. There are barely any echoes remaining from what once was. Time, inattention, tribal wars, deterioration, and misused or non-existent funds have all taken a great toll on people, facilities, and infrastructure.

But that's not to say there's nothing left out there to chase. Quite a few active stations remain, even if most are but a shadow of their former selves. They range from pretty easy to hear and go south from there. Here's a review of the French Africans and where and when to look for them.

A Brief Background And Current Catches

The French controlled a good part of the continent at one time. With a couple of exceptions most of their territory was comprised of two huge areas: French West Africa, with its capital at Dakar, and French Equatorial Africa, with Brazzaville as its capital.

The map of the continent changed considerably in 1960 when these two areas were split into a lot of smaller countries. French

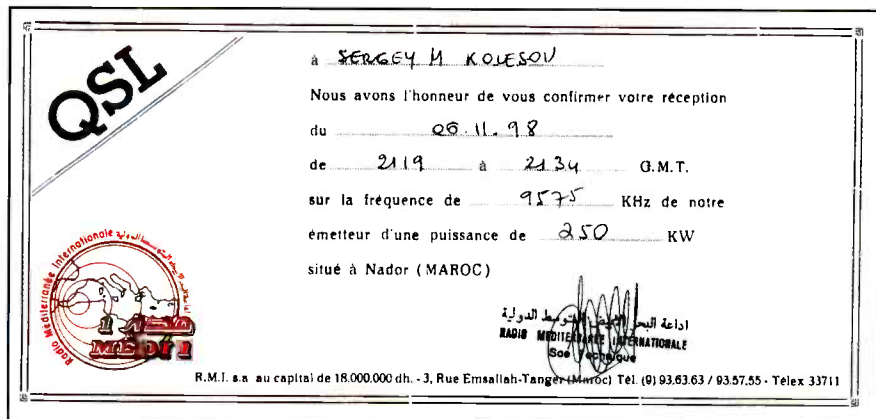

Morocco's private broadcaster Radio Medi-un is often heard on 9575.

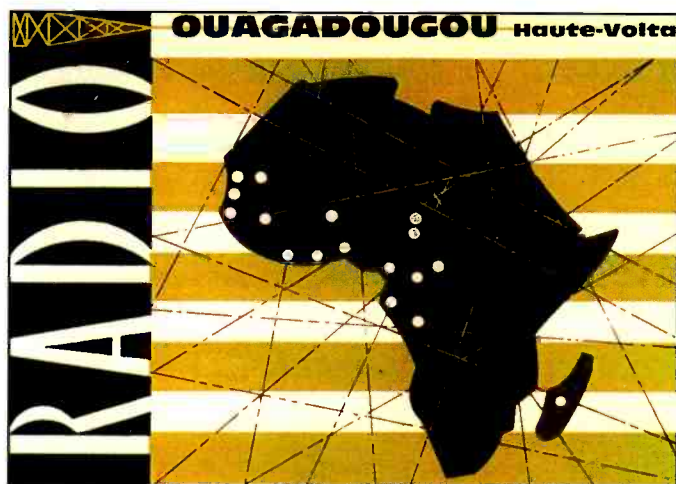

Back in 1961, Radio Unpronounceable was issuing this card.

West Africa was sliced up into Dahomey (now Benin), Upper Volta (now Burkina-Faso), Ivory Coast (Cote D'Ivoire), Gabon, Guinea, Mali, Mauritania, Niger, and Senegal. French Equatorial Africa was divided into the Central African Republic, Chad (or Tchad), and the Congo (now officially the People's Republic of).

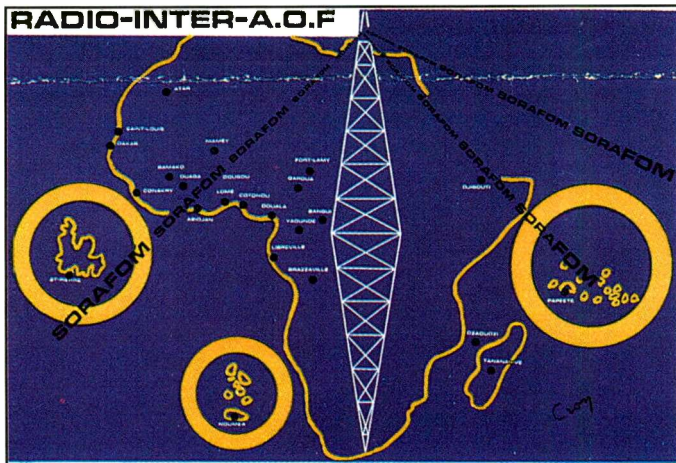

Many of the French Africans issued cards with this design a year or two before they obtained their independence.

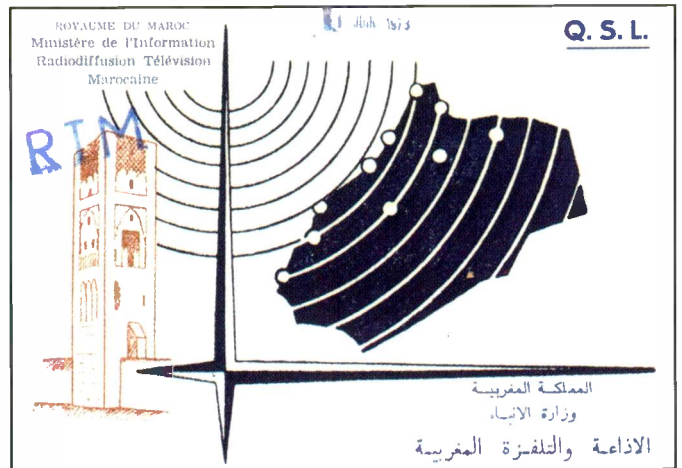

RTV Marocaine is well heard on some of its 19-meter band frequencies. Try 15335 or 15345.

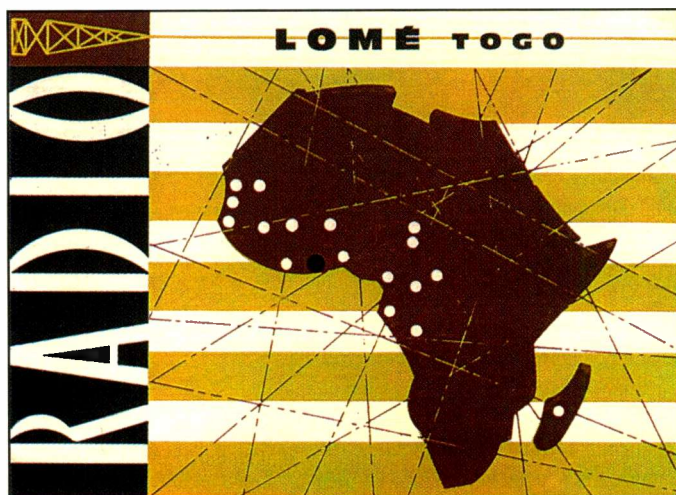

Forty years ago, Radio Togo was on 5047 and remains there today.

A few others, such as Algeria and Morocco on the north coast, were not part of these geographical behemoths and, in fact, had gained independence some years prior to 1960.

Here's what's left to seek out. Note that those countries with sizeable Muslim populations may run extended schedules on Fridays, as well as during the Muslim holy month of Ramadan. Incidentally, if you plan to send reception reports you'll get much better results if you can manage to write your report in French.

ALGERIA—Radio Algiers International is one of the few French Africans with a more or less real international service although, since it's aimed entirely at Europe, it is fairly difficult to hear in North America. The station is active daily from 1600 to 2000 with programming in English and Spanish on **11715**, **15160**, and **15215**. In the past it's been known to carry 15-minute segments from one revolutionary group or another, but that seems not to be the case at present. Reports go to 21 Blvd des Martyrs, Algiers 16000.

BURKINA FASO—Radio Burkina (aka Radiodiffusion Nationale du Burkina) supposedly runs 100 kW on **5030** from 1700 to 0000 and again from 0530 to 0830. Their old frequency of **4815** is used on a standby basis, so if 5030 isn't there try 4815, but 5030 is well and widely heard in most of North

America. Another frequency, **7230**, is listed for use from 0800 to 0900 (1200 on weekends) and from 1200 to 1700, though the latter won't do you any good. Reports for Radio Burkina go to B.P. (that's Boite Postal or P.O. Box) 7209, Ouagadougou.

CAMEROON—Cameroon Radio/TV isn't even active from the capital Yaounde any more. In addition to Yaounde (4975) there were stations in such towns as Douala (4795), Bafoussam (4000), Bertoua (4750), and Buea (3970). Now, about the only activity is on FM (there are no mediumwave stations at all!). The only thing left on shortwave is an outlet at Garoua on **5010**, and there's some doubt about even this one—it may be active or it may not be, or it may be a little of both. If and when it's on, listen for a 0430 sign on. Reports should go to B.P. 103, Garoua.

CENTRAL AFRICAN REPUBLIC—RTV Centrafricaine in Bangui occupies **5035**, **6100**, and **7270** from 0430 to 2100, though it may run an hour or so later on some occasions. We can stick 6100 in the "forget it" box as it is rarely reported, if at all, but the other two offer some chance. They are supposed to be running 100 kW, but there may be one too many zeros in that figure. Reports go to B.P. 940, Bangui.

CHAD—Name your night; Radio Nationale Tchadienne was almost an absolute guaranteed reception on 4904.5 up until a few years ago. But like some others, someone talked them into junking 60 meters and moving to 49. Maybe that was good for local reception but it certainly wasn't the case for us. They're listed at **6165** now, running from 0425 to 0730 and again from 1000 to 2230. Unhappily, the 49-meter frequency hasn't been reported in North America in years—perhaps never. Reception reports—or, for that matter, a letter asking them to move back to 4904.5—should go to B.P. 5808, N'Djamena.

CONGO—In the really olden days Radio Brazzaville was one of Africa's big guns. Yours truly used to come home from school, tune the old Hallicrafters to **11970** at about 4:45 p.m. and listen to the news, loud and clear—and in English, yet! Today, Radio Congo doesn't even come close to what Radio Brazzaville once was. But things are still better than they were a few years ago when there was virtually *no* service on shortwave at all. Now, at least, there's something to aim at. During the winter months you should have a fairly good shot at them on **5985** from 0430 sign on, and again just before sign off at 2130 or later, the latter time especially if you live in EST-land. Reports go to B.P. 2490, Brazzaville.

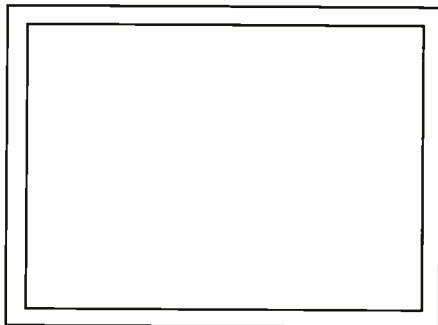

Today, this is what you get from Guinea!

IVORY COAST—It's not 100 percent sure, but it looks like RTV Ivoirienne has left shortwave. Once a regular on 4940 during the later evening, this station drove DXers crazy by seeming to ignore 99 out of every 100 reception reports. And when they did answer that one in a hundred it was with a crummy mimeographed letter on the cheapest possible paper stock. And all the time they had a nice, printed QSL. Perhaps you've seen illustrations of the infamous "SWL de Abidjan" card.

GABON—RTV Gabonaise is another broadcaster now a shadow of its former self. At least it is still active, scheduled from 0500 to 2300 on **7270** but rarely heard at that time or on that frequency. The long-used **4777** is still listed and hopefully is still in use. If they should show, the address for letters is B.P. 10150, Libreville.

Africa Number One is one of the very few commercial broadcasters these former French colonies have allowed to operate on shortwave and it's also one of the better heard. It uses **9580** from 0500 to 2300, **17630** from 0700 to 1600, and **15475** from 1600 to 2100. The station also has FM outlets in several other French-African countries. Their address is B.P. 1, Libreville.

GUINEA—Formerly French Guinea, the government station RFO Guyane is supposedly active on **5055** around the clock using 10 kW. But you'll do much better by trying **7125** at 0555 sign on or, given the right season and location (winter/EST-land), up until closing at 0000. If only the QSLs were as easy! These people are devilishly lax, or maybe as low-paid government employees they just don't give a damn. Occasionally they will deign to answer someone by e-mail. But open an envelope? Fill out a card? Put stamps on? Forget it! If you think you'll be that one in a million to get a real reply, B.P. 391, Conakry will be your first step



A Radio Tunisia card from years ago was in a folder format, with another folder inside showing the QSL information.

in a long and extremely frustrating effort.

MALI—RTV Malienne has remained pretty stable over the years. You'll find them on a "good African night" on **4783**, **4835**, or **5995** from 0555 sign on (to 0800) and also from 1800 to 0000. They're also scheduled from 0800 to 1800 on **7285**, **9635**, and **11960** (the latter frequency occasionally reported) and 1000 to 1500 on **7185**. Reports go to B.P. 171, Bamako.

MAURITANIA—Radio Mauritanie almost certainly had an upgrade a year or two back because about that time they began putting in an extremely strong signal on 4845 in the late afternoons, as well as later in the evening. This is supposedly a 100-kW transmitter (and this time we believe it!). They're scheduled from 1800 to 0100 and 0630 to 0830 on **4845** plus 0800 to 1700 on **7245**. Reports go to B.P. 200, Nouakchott.

MOROCCO—This North African nation has seen a quite a lot of radio activity over the years, including a Voice of America relay at Tangiers (long closed) and the long defunct Voice of Tangiers, which eventually moved to Monaco and became the first of the stations we know as Trans World Radio. The VOA (plus Radio Free Europe/Radio Liberty/Radio Free Iraq/Radio Free Asia) now broadcasts from the IBB relay station at Briech.

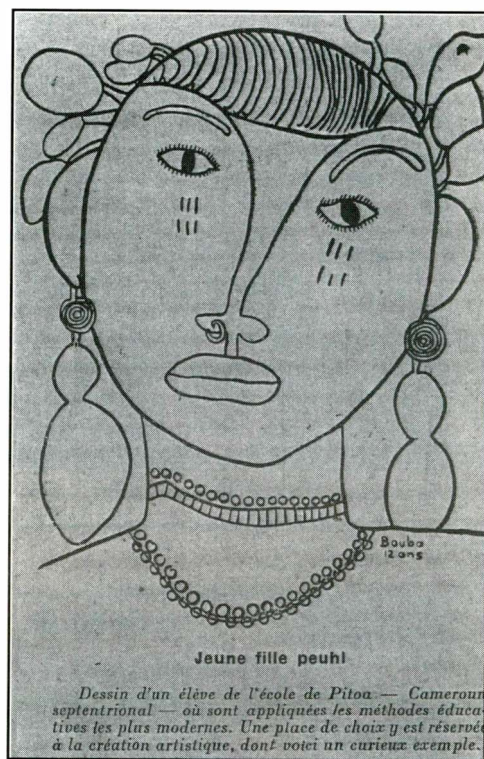

Radiodifusion du Cameroon issued this card back in 1957.

But we won't get into those long schedules since we're not dealing with foreign relays here.

Radiodifusion Television Marocaine operates one of the more extensive services of those we've discussed. It's active from 0000 to 0500 on **5980** and **7185**, 0900 to 1500 on **15340** (from Rabat), 1100 to 1500 on **15280** and **15335**, 1500 to 2200 on **15345** (Rabat), and 2200 to 0000 on **5980** and **7135**. All of these are in Arabic. French goes out from 1400 to 1700 on **17795** and 1700 to 1900 on **17815**. All the non-Rabat frequencies are from Tangiers. Your best bets should be **15335** and **15345** in local afternoons. RTM's address is B.P. 1042, Rabat.

Another private broadcaster is Radio Medi-Un (Radio Mediterranee International) an independent station that airs programs in French and Arabic on **9575** from 0500 to 0200 and can be heard in North America fairly frequently. They do pretty well with QSLs, too. Reports go to 3 rue Esmallah, Tangier.

NIGER—Like some others, La Voix du Sahel has saddled up to the higher frequencies, and in doing so hasn't helped itself much. Supposedly **9705** is active with 100 kW between 0500 and 2200 with French and local languages, but it's rarely reported in North America. The old **5020**

RADIO SENEGAL



Radio Senegal's card dating back some 40 years shows the station's situation today: a dead fish!

frequency is still active and normally also signs on at 0500. Place your bets on the latter frequency, given enough attempts. Reports go to B.P. 452, Niamey.

SENEGAL—"Ici Dakar," they used to say. But this station, which used to have the main gig in French West Africa, seems to be mostly silent these days. They were always a rock on **4890**, which is now occupied by a Radio France International relay in Gabon. There are occasional reports of a Senegal signal on 4890 but probably the DXer had RFI instead. Still, one can always hope.

TOGO—Another benchmark station in trouble is RT Togolaise (Radio Togo), always a regular on **5047**. Last year they seemed to be inactive, but there have been some reports recently that the station has been reactivated so it wouldn't hurt to check this spot on an evening every now and then, just in case something pops up around their supposed 0400 sign on. If it happens, their address is B.P. 434, Lome.

TUNISIA—Here's one which provides reception good enough to just kick back and listen! RTV Tunisienne is tunable night and day. They operate on the following schedule: 0200 to 0500 on **9720**, **12005**; 0400 to 0700 on **7190**, **7275**; 1200 to 1700 on **15450** and **17735**; 1400 to 1700 on **11730**; 1400 to 1900 on **12005**; 1700 to 2130 on **9720**; 1700 to 2300 on **7275**, and 1900 to 2300 on **7190**. Reports go to 71 Ave. de la Liberte, TN-1070, Tunis.

Good luck in chasing all of these down. And vive la whatever!

" RADIO - CONAKRY "
Radiodiffusion de la Guinée
Française

CONAKRY, le 12 Août 1957

Emettant sur :
- 48 m. 74 - (6.155 Kcs)
- 61 m. 10 - (3.376 Kcs)
- 88 m. 89 - (3.376 Kcs)

Le Chef du Service de
L'INFORMATION ET DE LA RADIODIFFUSION...

à

BOITE POSTALE 617
CONAKRY (A.O.F.)

Monsieur *Gerry Dexter*
144 Windsor Drive
Wataala - Iowa - (U.S.A.)

Monsieur,

J'ai bien reçu votre lettre du 6 Août 1957 et vous confirme que le programme que vous avez capté le 6 Août 1957 à 8452 (9.M.T.) est bien celui diffusé par notre Station d'Emission.

Radio-CONAKRY qui ne disposait auparavant que d'un émetteur de 1 kw, vient d'être doté récemment d'un émetteur beaucoup plus puissant : 4 kws.

Parallèlement, les heures d'émission ont été notablement augmentées et "RADIO-CONAKRY" diffuse depuis le 2 Juin 1957, trois émissions par jour :

- le matin : de 6 h.30 à 7 h.30 GMT (sauf le dimanche où l'émission a lieu de 10 h. à 13 h.30 sans interruption)
 - le midi : de midi 15 à 13 h.15 GMT (samedi et dimanche jusqu'à 13 h.30)
 - le soir : de 18 h.30 à 19 h.45 GMT (émission en langues vernaculaires)
- et de 19 h.45 à 21 h.30 (samedi et dimanche jusqu'à 22 h.)

Je suis heureux de vous compter parmi les auditeurs de "RADIO-CONAKRY" et espère que vous continuerez à me faire parvenir vos résultats d'écoute.

Je vous prie d'agréer, Monsieur, l'expression de mes sentiments distingués.



It was Radio Conakry in 1957, and the best one could do was a mimeographed form letter on very poor paper. At least they replied in those days.

ATOMIC TIME

1010 Jorie Blvd. #332
Oak Brook, IL 60523



Atomic Time 12" Modern Black

918/3321.00 \$34.95

The black wall clock with arabic numerals is great for home or office use. This clock features the German made Hechinger radio-controlled movement.

Atomic Time Analog Sport

< 065/1011 Black \$99.95
< 065/1010 White \$99.95

German made atomic watch with readout for digital seconds. Can display any world time.



Atomic Time Thermo-Calender

< 306T21 \$29.95

This clock is able to display time in 12 hour or 24 hour format. It also shows the date, the day of the week, the temperature, and signal reception. Automatically adjusts for daylight saving.

1-800-985-TIME
www.atomictime.com



918/3321.00



Atomic Time Clock Radio ^ RCL-19 \$29.95

AM/FM radio with dual alarms, temperature, and date display. Includes an AC adapter and an optional external antenna to help reception.

Tell time by the U.S. Atomic Clock -The official U.S. time that governs ship movements, radio stations, space flights, and warplanes. With small radio receivers hidden inside our timepieces, they automatically synchronize to the U.S. Atomic Clock (which measures each second of time as 9,192,631,770 vibrations of a cesium 133 atom in a vacuum) and give time which is accurate to 1 second every million years. Our timepieces even account automatically for daylight saving time, leap years, and leap seconds. \$7.95 Shipping & Handling. (Rush available at additional cost) Call M-F 9-5 CST for our free catalog.

Galaxy's DX 959 AM/SSB Mobile CB And K40's Trucker Antenna

If you're a CB enthusiast—especially one who stays within the limits of the law—yet wants equipment that stands out in the crowd, read on. This review is as much about buying and using good equipment as it is about not having to splatter the band with over-powered radios just to be heard.

The Galaxy DX 959

Over the past few months I've had the pleasure of using the combination of the Galaxy DX 959 mobile CB and K40's Trucker antenna with excellent results and a lot of positive comments. I travel to several hamfests and radio club meetings throughout the year, renting vehicles from vans and SUVs to small cars. (Frankly, in our personal car—that's probably a lot like yours—there's little room to properly mount a CB, so a temporary mounting solution for the radio *and* antenna is in order). The Galaxy DX 959 fits the bill for mounting ease and durability. On the last several road trips I've used everything from super-heavy-duty hook-and-loop fastener (commonly referred to as Velcro), an old RadioShack "hump" mount, to a couple of good quality rubberized straps. The bottom line is that whatever you choose, make sure it's a secure mount: push, pull, and try to move the radio to ensure it's going to withstand the rigors of highway driving and sudden starts and stops.

I really think that the days of permanently bolting a CB transceiver to the under-dash area of a vehicle are long gone; manufacturers might just as well include a roll of hook-and-loop fastener or another kind of mounting gizmo beside, or instead of, the standard metal bracket and screws.

The Galaxy DX 959 is a full-featured mobile CB, offering all 40 channels with AM and SSB. For those folks unfamiliar with SSB (sideband) you'll get a lot of extra range between radios—remember that if you're using sideband, both operators need to be using that mode—in either the upper-sideband (USB) or lower-sideband (LSB). Then there's the standard AM mode which is what you'll find truckers (sorry, professional drivers!) using on Channel 19. The DX 959 puts out the full legal limit (4 watts on AM and about 12 watts PEP on sideband).

Features on the DX 959 include variable power output control with a maximum of 4 watts out (all other radios have a fixed output), Roger Beep, or as the amateurs say "End of Transmission Signal," and Talkback circuit so you can monitor your own voice.

The radio measures about 2 1/8 x 7 7/8 x 9 1/4 inches (HWD), weighs about 5 1/2 pounds and has a professional look and feel. Standard with the DX 959 is the plastic handheld microphone that connects to the left side of the radio (I would prefer a front-mounted mic so mounting would be easier and the cord wouldn't get in the way of my steering wheel). It comes with a bottom-mounted speaker that's rated at two watts—certainly adequate audio output for most mobile operation. I had no problem hearing weak mobiles and base stations with the windows down on the interstates.



The Galaxy DX 959 ready to be installed. Note that in bright sunlight the radio's displays get washed out and are difficult to read. Checking the SWR on Channel 19 with the MFJ meter shows a 1.5:1 reading using the K40 Trucker antenna.

Because the DX 959 also features sideband, there are more controls on the radio than a standard 40-channel AM-only transceiver, including the Clarifier knob that fine-tunes a received signal, and, of course, the Mode switch that enables you to choose between AM, LSB, and USB. They're all easy to use, even with fairly large fingers. Also included is a NB/ANL switch that enables a noise blanker/automatic noise limiter. I found using the noise blanker effective at nearly eliminating electrical pulses and the usual ignition noises you'll encounter on the highway, not just from your own vehicle, but from others, too.

Galaxy has also thoughtfully provided a real *analog* S/R/F meter, which I found to be as accurate as those on any other CB I've recently used. The meter also includes a modulation scale (operates in AM only) and shows relative power output. It's large enough to see and is sufficiently illuminated. However, I wish the actual frequency display and separate channel display were as easy to read, especially on sunny days. Each display is large enough, but even on the brightest setting using the adjustable dimmer control, the numbers just aren't *bright enough* even in moderate sunlight. At night, however, both are highly visible.

The K40 Trucker Antenna

I used the Galaxy DX 959 with the K40 Trucker antenna. Now, if you're into CB, or even 10-meter ham activity, consider this superb antenna. It's built like a tank and certainly gives you the edge, both in transmit and receive. The K40 Trucker is

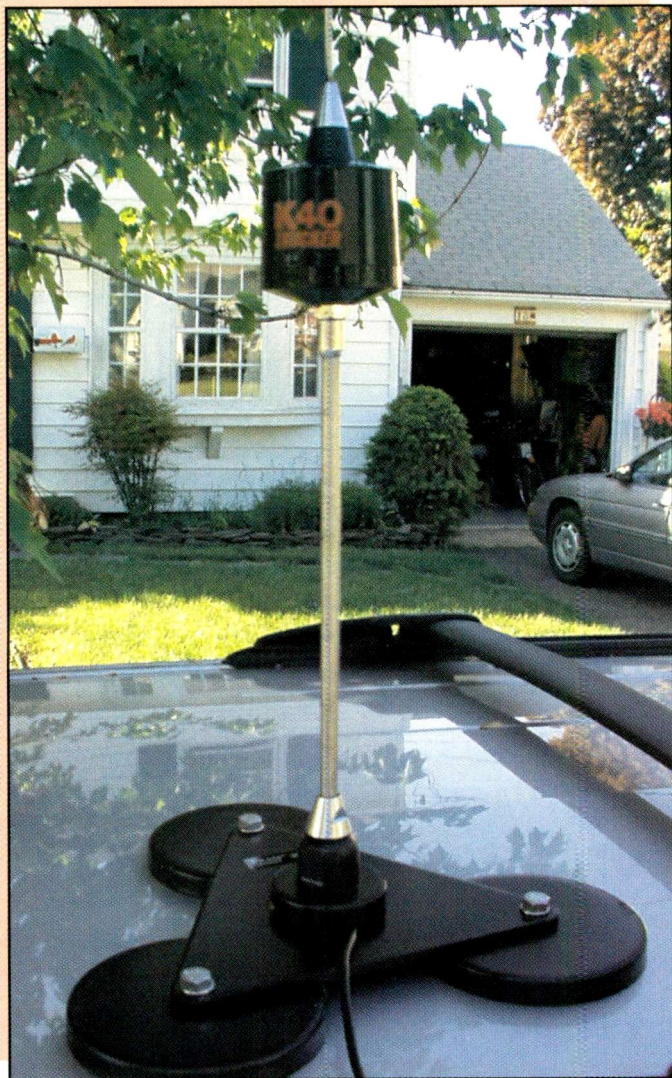

The K40 Trucker antenna mounted on the vehicle using a Tram five-inch magnet mount. You simply insert the whip into the coil, measure the distance from the tip to the top of the coil based on a frequency chart supplied with the antenna, and you're on the air!

a center-loaded antenna that's tunable from 26 to 30 MHz. I mounted it in a heavy-duty Tram magnet mount, which has three five-inch magnets, coax, and 3/8-inch x 24 thread adaptability, but you can screw the K40's standard thread into a bumper or mirror mount. K40 sells several mounts, one of which I'm sure will work for your mobile installation.

The K40 trucker antenna is easier to assemble and use than most other CB antennas I've reviewed. It comes complete with a small tool to adjust the length of the whip inside the coil assembly. Simply look at the chart and insert the whip into the coil's hole with the appropriate length exposed above the coil and you're on the air. You might have to cut the whip for some frequencies. With the DX 959 and the K40 Trucker mounted on the roof of a medium-sized car, the SWR was under 1.5:1 on Channel 19; slightly higher on Channel 40, but then again, how often do you use either Channel 40 or Channel 1? It doesn't matter because if you want to operate nearer the band edges, or even on 10-meters, the chart covers those frequencies too. No fuss, no bother. Just follow the easy-to-understand directions

and hit the road. The DX 959 also offers a red high-SWR indicator lamp. If it lights, stop transmitting and check your antenna or coax because the SWR is higher than about 3:1.

On The Air

Okay, I'll admit it: I like talking on the CB radio and not just *listening* to some of the truckers' on-air antics. I really do enjoy CB and passing the miles with a little good, clean fun. When it gets a little rough, I turn down the volume for a few minutes.

Using the Galaxy DX 959 was a definite pleasure. The incoming audio was clear and crisp without distortion. I especially like the built-in SWR meter (flick the switch and you get a good indication of your antenna's performance without the need for an external meter and jumper cable). I did compare the 959's internal meter with one from MFJ Enterprises. The 959's built-in meter was right on the mark—very good! This certainly also speaks volumes for the K40 Trucker antenna, which itself was the topic of discussion with a couple of passing drivers. One had a mirror-mounted K40 and the other was using an oddball brand CB antenna he picked up at a truckstop. Needless to say after our conversation he was convinced K40 was the way to go!

Most of my contacts with the Galaxy DX 959 were on the interstates, but to fairly test both the antenna and radio I decided to move to a nearby channel, listen for local activity, and break in. There, over the skip, were two local operators talking about their breakfast at IHOP. I only needed to break in once to get their attention, asked where that IHOP was located, and proceeded to use their directions to get there in less time than it takes to eat a stack of those blueberry pancakes! One operator was on a base station about five miles away, the other in a mobile just off the interstate. As you might expect the base operator said my signal was "excellent—over the skip." The mobile operator said I was coming through the skip with good audio. I'll take *both* of those reports!

I wasn't able to make any sideband contacts locally, but one operator in Florida heard me trying to reach a fellow a few miles away and gave me a good signal and audio report. While I'm on the topic of using sideband, remember not to use sideband on Channel 19; you'll only raise the blood pressure of already stressed-out drivers and won't make any friends. Save sideband for Channels 36 to 40.

A Winning Combination

The bottom line is that I found the Galaxy DX 959 to be an excellent CB transceiver that's road-worthy with the right antenna. My antenna of choice is a K40 Trucker, which also doubles as a superb 10-meter ham antenna!

Suggested retail for the Galaxy DX 959 mobile CB is \$219.95, although common prices at truckstops are about \$199.95. It's covered by a limited two-year parts and labor warranty. For more information on the DX 959, contact Galaxy at www.galaxyradios.com.

The K40 Trucker CB antenna carries a retail price of \$69.95 and has a 30-day money-back performance guarantee and five-year quality guarantee. K40 can be reached at www.k40.com or by calling 800-323-6768.

Be sure to tell K40 and Galaxy you read about their products in *Pop'Comm*! ■

One Number, One Base Wireless Phone

On November 24, the FCC will mandate wireless carriers to offer local number portability (LNP). This will allow us to take our current wireless phone number if we switch from one wireless carrier to another. We will also be able to “port” our current landline phone number to a wireless phone.

Let’s say your present wireless carrier is not meeting your expectations, and you recently found out your present portable phone does not work out in the canyon nearly as well as your emergency communicator friend’s tiny unit. You are part of the same rescue squad, and your regular training in this canyon without adequate cell phone coverage causes you to miss numerous incoming calls. Your local cell phone dealer is eager to switch you to another service called “churning,” because that cell phone dealer picks up a new account bonus that will bring in more money than simply selling you a more advanced handset that probably wouldn’t work any better than your old one.

But, prior to this November ruling, your new service provider would have assigned you a brand new phone number. Meanwhile, your current cell phone number would have been printed on a gazillion business cards, plus have been part of the call-up tree number at your local rescue squad. But now, after November 24, you can switch services and take your old number with you.

Now let’s say in that same canyon is a retired fire chief and that same rescue squad founder who has a 20-year-old landline phone number with the last four digits “0911.” He wouldn’t give up this phone number for the world, and now, with local number portability on the books, the chief will be able to “port” his current landline phone number to the wireless system that works best deep inside the canyon.

Is there a cell phone that might work better in rough terrain where coverage is spotty to the portables? There sure is. The equipment, called Base One, is a dual-mode, TDMA, digital, fixed, wireless phone compatible with popular time division multiple access as well as older analog carriers offering service in many rural regions.

“The high-power transmitter and more sensitive receiver results in better signal range than handheld cellular phones,” commented James White, representative for the Base One base-type phone, manufactured by CSI Wireless in Canada (www.csi-wireless.com).

“Cut the cord on the wired service at home or office or remote locations—this unit plugs into a standard AC outlet, or runs off of common battery voltage in case of a power interruption, and is absolutely wireless,” said White. He added that the typical signal processing delays and typical pinched audio do not show up on the Base One phone.

The Base One phone offers 3 watts output in TDMA digital, and .6 watts output in analog from its side-mounted TNC threaded output connector. This could allow our fire chief to run an external antenna up to the roof with low-loss coax cable and

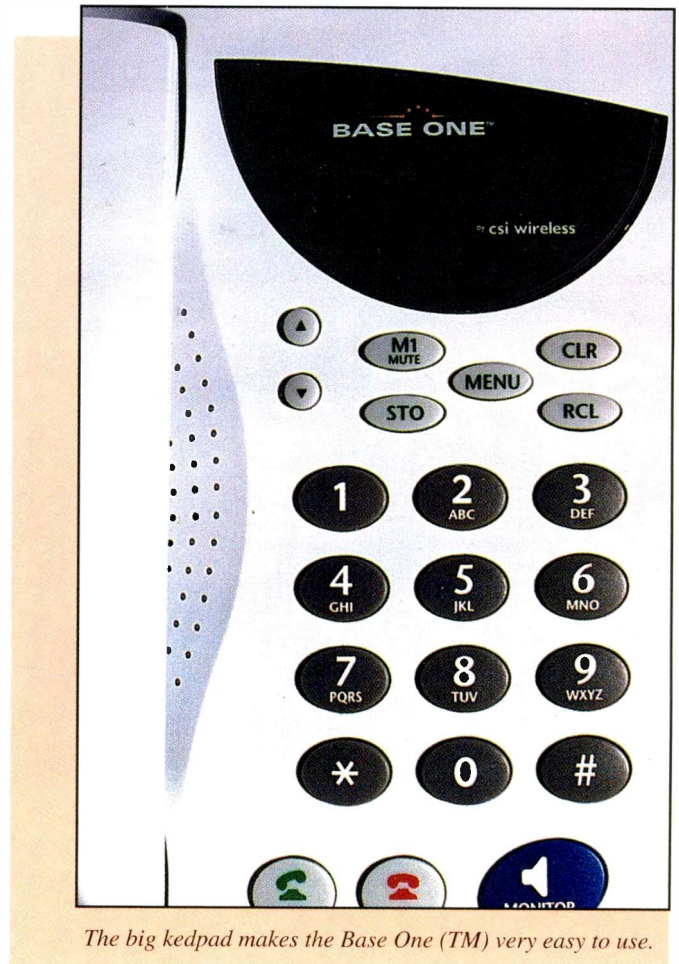

The big keypad makes the Base One (TM) very easy to use.

find the hot spot clear of multipath “drop outs” within the steep canyon. For the base station, a small Yagi tuned to the 800-MHz band would easily cover all 832 full-duplex channels.

The Base One phone I tested was loaded with features that you would normally expect out of any advanced corded or wireless phone apparatus, including:

- Big back-lit LCD display
- Intuitive menu system
- Eighty-nine memories
- Memory number search, review, and dial
- One-touch dialing
- One-touch emergency call
- Last 10 number dial recall
- Caller ID and three-way calling
- Voice-mail notification

The caller ID, three-way calling, and voice-mail notification rely on services offered by the carrier and may cost a little extra. “A user with a wired phone will likely find their current carri-

LENTINI COMMUNICATIONS, INC.

YAESU



VR-500
Hi Performance
Mini Receiver
Call For \$\$



VX-2R
Tiny Dualband HT
w/CTCSS/DCS
Wideband RX
500kHz-960MHz
less cell
Call For \$\$

VR-120D
100kHz - 1300MHz
Receiver
w/Ext. DC Input
Call For \$\$



VR-5000
All Mode Receiver
Call For \$\$

SONY SHORTWAVE IN STOCK!

RANGER COMMUNICATIONS	
RCI-2995 DX.....	\$599.00
RCI-2985 DX.....	\$479.00
RCI-2950 DX.....	\$299.00
RCI-2970 DX.....	\$429.00
RCI-5054 DX 6M Mobile.....	\$299.00
RCI-5054 DX 100 New 100W 6M.....	\$399.00
RCI-6300 FTB 10M Mobile 100W.....	\$399.00
RCI-6900 FTB 10M SSB 100W.....	\$449.00

ALINCO

DJ-X10T **DJ-X3T**
\$319.95 \$209.95
DJ-X2000T
\$499.95

GRUNDIG Shortwave

Grundig Satellit 800
\$499.95 + \$15 UPS
Yacht Boy 400PE
\$149.95 UPS Included
Yacht Boy 205
Analog Shortwave
SALE \$49.95

AOR

USA, Inc
AR8200
MARK IIIB
\$569.95
AR8600 Mark II
NEW! \$889.95

ICOM

PCR1000 BON
Receiver For computer
Now With Bonito Software
Call For \$\$

IC-R8500
Wideband Receiver
Call For \$\$

IC-R75
HF Receiver
Call For \$\$

NEW
IC-R5
Compact Receiver
150kHz-1.3GHz
Call For \$\$

IC-R10
Wideband
All Mode RX
Special \$299.95
UPS Included

IC-R3
Receiver
w/2" TFT Display
Call For \$\$

uniden

NEW
Uniden Digital Scanners APCO 25 Digital Capable
BC250D **BC785D** **BCi25D**
Handheld Mobile/Base APCO Digital Card
\$349.95 \$349.95 \$299.95
BC895XLT **BC245XLT** **BC780XLT**
\$199.95 \$199.95 \$299.95
Free UPS Ground

SCANCAT GOLD scanning program software...\$99.95
SCANCAT GOLD SE\$159.95
C278CLT...\$149.95 BC80XLT...\$119.95 SC180.....\$174.95
BC248CLT.\$109.95 BC60XLT.....\$94.95 SC200.....\$199.95
BC350.....\$109.95 BCT7.....\$179.95



HOURS: M-F 10am - 6pm SAT 10am-4pm
(June-August-Saturday 10am-1pm) UPS Ground (48 states)
C.O.D.'s OK Same Day Shipping

Conn Sales Infor. & Tech Help 860-666-6227 • FAX 860-667-3561 • 21 Garfield St., Newington, CT 06111
www.lentiniComm.com Toll Free 800-666-0908

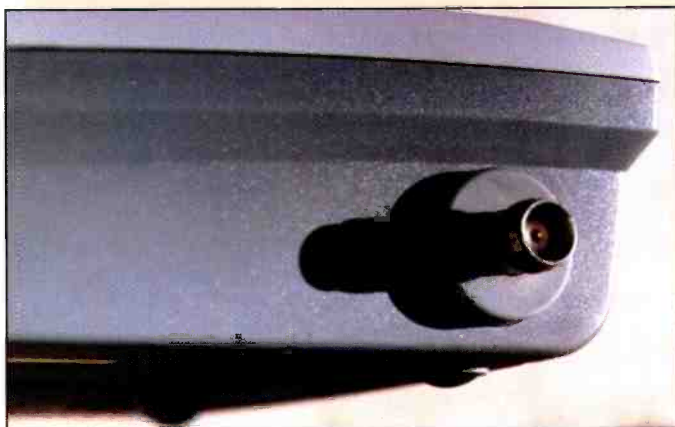

An 800 MHz external antenna plugs in here.

er offering a portable cell phone plan called 'add a phone' that would add service for this phone for around \$15 per month. That's about one-half what a customer would normally pay for a second landline phone at home," said White, speaking about fixed-phone-like service for the elderly or for college students who might take their personal phone with them from home to dorm, and back again.

The big phone apparatus from Base One has yet another benefit at an emergency command center: it looks and sounds just like a regular hard-wired phone. Most people picking up the handset and dialing a call or taking an incoming call won't realize that the phone system is totally wireless. Unlike a tiny cell phone that has dead spots inside a metal mobile home, an out-



The wireless Base One cell phone with detachable antenna.

side antenna to this phone makes it ring, sound like, and handle like a regular fixed-line phone.

So with LNP now here, you now have options to take your phone number with you. And if you want a fixed-phone-like apparatus that anyone can use, Base One from Brightstar may be the ultimate answer!

Midland And Topaz3 Join Forces

Midland Radio Corporation and Topaz3 LLC announced that business operations of Topaz3 have been combined into Midland Radio Corporation. The expanded Midland Radio Corporation includes engineering, manufacturing, direct sales, marketing, and product distribution at its North Kansas City headquarters.

"It is an exciting time for us," said Dan Devling, who has joined Midland as its President. "This combination will give us a stronger position in the marketplace, provide more opportunity for growth, and better utilize our combined resources to maximize customer satisfaction."

Midland is a leader in the consumer radio market for FRS, GMRS, CB, and weather/all-hazard alert radios as well as in the Land Mobile Radio market with a wide selection of portables, mobiles, and high-powered base stations. Midland also markets a new RoIP radio solution that economically integrates two-way radio and Internet communications to allow greater flexibility in voice and data transmission. It is currently being deployed by several government agencies and commercial enterprises across the country.

Midland has gained the exclusive sales and marketing rights to the Maxon brand name for North, Central, and South America, as well as the Legacy and TruTalk brands, which are sold worldwide. Midland will also market the ComStar Automatic Vehicle Location (AVL) products and services with several AVL systems operational in United States.

"Under Midland Radio Corporation," said Tony Lane, Vice President of LMR sales, "the combined base of over 1,400 independent LMR dealers will have access to all the products and programs originally offered by the two companies. This will include Midland LMR, Maxon LMR, Legacy LMR, Midland Consumer Radio, TruTalk Consumer Radio, and ComStar AVL products and services."

Midland Radio Corporation, headquartered in North Kansas City, Missouri, is the U.S. affiliate of an international group of companies with offices in North America, Europe, and Asia.

Midland is one of the world's leading designers, manufacturers, and marketers of consumer and commercial communications products. It is the oldest manufacturer of CB radios in the U.S.

Emergency! What You Can Do

We've found out once again that it doesn't take an act of terrorism to make having radios and batteries a lifesaver. The blackout that affected millions in August—a fairly recent event as this issue is prepared—not only affected cell phones (pay phones were king!), but also strained police and other public safety communications assets. If you're equipped with a few simple basics, including two or three *small* flashlights (remember, *lighter is better* if you've got to pack up and run in a hurry) you're light years ahead of those who haven't taken the time to think ahead.

What can you do? Take it from those millions who were without the basics that being prepared is everyone's job. Always have

fresh alkaline batteries on hand and a simple battery operated radio. I always have about 28 "AA" alkaline batteries in a small box, sufficient to power a couple of radios and flashlights. While you're thinking about radio basics, take the time to write down your local stations' call letters, frequency, and location. Then, because you just never know when you'll need it, listen to the AM radio *at night* and write down the big guns you hear. This way you won't be sitting there for a half-hour wondering what station you've tuned and if the broadcast information is important for you and your family.

If the chips were down and you were separated from your family or co-workers could you effectively communicate? Buy a few of those inexpensive FRS radios or GMRS handhelds; keep the batteries charged, or better yet, use alkaline batteries—they usually last longer than rechargeables. Besides, if the power is out, rechargeable batteries suddenly become useless after they're drained.

Don't forget the NOAA radio. Today they're less expensive than a night out on the town, and *you* get the tips! Many have battery back-up, and most are equipped with S.A.M.E. (Specific Area Message Encoding) technology, which allows you to program the radio to receive only warnings for your immediate area. This way you aren't alerted for weather or disasters five counties away. If it activates with the siren and announcement, it's time to take major precautions.

Do you know where your emergency shelter is located? Find it today. Is it within walking distance? Does that small FRS or GMRS handheld make the trip, or do you need a little more horsepower? *You and your spouse* might want to consider getting a ham license, which will enable you to communicate more effectively. Besides, many of the handheld ham radios are also good scanners, so you'll be able to program a few local public safety and emergency frequencies to stay on top of the event.

Remember: A few simple basics, common sense, and planning will help you and your family through many disasters fairly comfortably and safely. Make a list of your supplies and ideas and talk about it with your family and friends.

Cracker Barrel, Anyone?

Okay, I'll admit it—if there's an opportunity to visit the Barrel when on the road, I'm there before you can say "maple pancakes and coffee." After a recent radio club meeting, a few of the gang and I stopped there for lunch...and dessert. Being radio nuts, it wasn't long before we wondered what the frequency is for their headset radios. I've checked the famous Internet and found two, **159.555** and **159.855**, but the next time we had lunch there, it netted nothing.

Instead of sitting at a table with a coffee in one hand and frequency counter in the other, I thought another died-in-the-wool Cracker Barrel fan might know the frequencies. Drop us a line and we'll print your letter here, along with the frequencies. And if you really have to ask why we'd want to listen in, you're just not as radio crazy as we are! ■

IC-PCR1000

TURN YOUR PC INTO A WIDE BAND RECEIVER WITH ICOM'S LITTLE BLACK BOX!

Now with
Bonito Software!

Volume Squelch - points to the volume and squelch controls in the software interface.

Sound Card Controls - points to the audio parameter section in the software interface.

Modes - points to the mode selection buttons in the software interface.

Memory Channels - points to the memory channel list in the software interface.

Functions - points to various function buttons in the software interface.

Digital Decoder/DSP Functions - points to the decoder and DSP control sections in the software interface.

Filter Softening - points to the filter softening controls in the software interface.

- 100 kHz – 1.3 GHz!
- AM, FM, WFM, USB, LSB, CW
- Unlimited Memory Channels
- Real Time Band Scope
- IF Shift
- Noise Blanker
- Digital AFC
- Voice Scan Control
- Attenuator
- Tunable Bandpass Filters
- AGC Function
- S Meter Squelch
- CTCSS Tone Squelch
- Computer Controlled DSP

Turn your PC into a Wide Band Receiver! ICOM's IC-PCR1000 uses the power of your computer to open a new world of listening and viewing pleasure. Compatible with most PCs and laptops running Windows™ software, the 'PCR1000 connects externally -- in just minutes! The new Bonito software (BON CS40) expands and enhances the 'PCR1000's versatility with the following features:

Basic Radio Control functions with spectrum scope

Computer Controlled DSP for tailoring your audio with separate bass & treble controls

Filter Smoothing for the upper and lower ends of the audio spectrum

Notch Filter reduces annoying pops, buzzes, & other interference for a crisp, clear signal. Use the power of your computer's sound card DSP to bring out the beauty of the signal for hours of enjoyable listening

Digital Decoding Package transforms your computer into a decoding machine. You no longer have to purchase an external decoder for receiving non-encrypted digital modes. Digital Decoding allows you to decode: **RTTY, FAX** with *Zoom, Synchronize, Slant Correction, Cut a Picture, Picture Invert and Rotate*, **CW, SSTV** with *Auto Sync, Slant Corrections, Sitor-B, PSK31*

Audio Record function allows you to record your favorite radio programs, local traffic, or almost anything else with your computer's sound card and hard drive. Save for friends and family to listen at a later time

See your authorized ICOM dealer for more details.

download frequencies
right from the web
www.icomreceivers.com

New Windows™ OS? No problem! Updated ICOM software is now available for free download!
Download at www.icomamerica.com. Click Receivers>IC-PCR1000>IC-PCR1000 software (updated)

*Cellular frequencies blocked; unblocked versions available to FCC approved users.
©2003 Icom America Inc. The Icom logo is a registered trademark of Icom Inc. All specifications are subject to change without notice or obligation. 6174

The world is waiting
www.icomamerica.com

ICOM®

Prolog: The Big Blackout

Originally I had this column finalized in early August. Then, shortly after 4 p.m. EDT on August 14, came the **BIG EAST COAST BLACKOUT!** Initial reports indicated that a relatively small energy supplier to the Eastern Power Grid suffered some malfunction that took them out of the grid. Several others followed in the ensuing *nine* seconds, and the result was the largest power outage in the history of the United States. *Nine seconds!* That's all it took to plunge all of New York City, Toronto, Ottawa, New Haven, Cleveland, Akron, Erie, et al, into a "power vacuum."

Having never ridden the NYC subway system, I cannot even come close to imagining the utter terror that many must have felt being suddenly stranded in total darkness below ground without power, lights, and transportation in the middle of evening rush hour. Then there were the folks who had to walk down 30 to 50 flights of stairs to exit their high-rise work places, only to find the traffic on the streets was at a standstill and they would have to walk miles to reach the ferries in order to leave Manhattan for New Jersey.

As I sat watching this unfold on television, my mind was reeling under the impact of what had just transpired. No terrorist incident had caused this chaos. Just a simple failure of one of the suppliers of the Eastern Power Grid caused a cascading effect across the Northeast, Midwest, and Canada, plunging millions of people into pandemonium in only **NINE SECONDS!** Half of the 19 million people living in New York State were immediately and directly affected by the blackout. Nine nuclear power production plants were shutdown as a result of this power outage, and between 9,000 and 10,000 NYC police officers were placed on scene to provide security and to ensure the safety of New Yorkers. Imagine that overtime bill!

Ready? Or Not?

While I was watching the events unfold on television, I started mentally going over my own plans for weathering a power outage, in case this outage suddenly started to widen to include northeast Pennsylvania. I grabbed three five-gallon gasoline containers and headed to the filling station to top them off for my 4-kW generator. At that time I also filled the truck. Remember to *always* drive on the top half of your gas tank. You can't pump gas if there is no power available.

Arriving back home, I topped off the generator and located the umbilical cable that connects the generator to my home electrical service. Then I grabbed the two ham handie-talkies and plugged them into their respective chargers; likewise with the FT-817 and the cell phone.

While my little 4-kW generator will furnish the house with enough power to run critical systems (the furnace in the winter time, and the fridge and freezer along with some creature comforts like the television, sat receiver, and lights), it won't allow me to run the air conditioning. Oh, well, I'd rather be hot and sweaty watching TV during a blackout rather than hot, sweaty, and in the dark with no power at all.



A small 7.5-amp-hour sealed battery taken from a back-up UPS unit.

My radio room runs on 12 VDC via a deep cycle battery under intermittent charge from an integral AC charger. I have a spare battery, kept fully charged, in case I need to swap them out during an extended power outage. The only thing I cannot run via 12 VDC is the Ham-M antenna rotor for the HF beam. Since most of the HF emergency communications I will likely encounter will be on 3.5, 5, or 7 MHz, my 40-meter Extended Double Zepp will facilitate local and long-haul comms.

We had bottled water in stock, the fridge and freezers were full, and I had spare bottled gas for the gas grill. I was as ready as I possibly could be in case the power outage started to widen. (Add a closet full of guns, a couple cases of booze, and a tall red head, and I'm ready for Armageddon!)

This column started out as the first installment of a multi-part tutorial on power for emergency communications. The events of August 14 and the *Big East Coast Blackout* provided an excellent segue for this month's "HOMSEC" column.

Power, the "Secret" Ingredient

Power is a valuable commodity, especially when you really need it and don't have it. Obtaining usable power is something every emergency communicator has to deal with. And, since Edsel Murphy lives for things like emergencies, you'll never have the power you need at the time you need it most. No matter how much gear you have, you can't use it if you can't turn it on!

One of my favorite sci-fi books is *Lucifer's Hammer* by Jerry Pournell and Larry Niven. It's basically an end-of-the-world-as-we-know-it novel involving a comet that hits Earth and the ensuing chaos and anarchy that follows. One quote by a main char-

acter in the novel centers upon the need to secure and bring on-line a newly constructed nuclear power plant. After heated discussion among the main characters, the patriarch of the group says something like, "Give my children the lightning," referring to the activation of the nuke plant. Although written in the mid-1970s, *Lucifer's Hammer* offers some sound insight into the catastrophic upheaval of society on a grand scale. Scientifically the book is also sound regarding what would happen if a comet or part of a comet (asteroid, space rock, etc.) of considerable size hit our planet. The one theme that ran through the entire book was the need for electrical power to enable us to do *anything*.

As emergency communications (EMCOMM) volunteers we need to be *very* aware of the power budget(s) that our gear requires. Face it, you can have a whole warehouse full of equipment but without the electrical power (either AC mains or DC) to run that gear, you are "high and dry" and unable to provide needed communications during an emergency or disaster.

The majority of our personal EMCOMM gear runs on DC, somewhere between 6 and 12 volts. Powering our comm gear is easily accomplished using vehicle batteries or deep cycle marine/RV batteries. Recharging these power sources can be accomplished by placing the depleted battery in a vehicle and using the vehicle's charging circuitry to top off the battery. Although it's not recommended, you can also recharge a deep cycle marine/RV battery in the same manner. Purists will argue that it will ruin the battery if done on a regular basis, however, during an emergency all bets are off. You do what you have to in order to stay on the air.

Things get a little more complicated should you decide to deploy with a laptop computer, printer, etc., as the need for AC power becomes critical. While most laptops and portable printers run on DC, it is often much higher than the nominal 6 to 12 volts that the comm gear takes. Most laptops and printers have an AC supply that works on 120 VAC input and produces a DC voltage that is compatible with the computing device (normally somewhere between 16 and 24 VDC). Problems arise when we need to power that portable computer gear from a standard 12-volt car or deep cycle marine/RV battery.

Enter the DC-to-AC inverter. This device takes a 12-VDC input and "transforms" it up to roughly 120 VAC. How is this accomplished? Would you believe "magic"? Oh well, I tried.

DC voltage cannot be used on a step-up or step-down transformer. To DC current, a transformer winding looks almost like a direct short circuit which will induce maximum current draw from the voltage source. The result? Something's gonna melt! So we have to do some "magic" to take that low voltage DC and turn it into an alternating current signal. Then we must raise that AC output signal to a useable level.

This is accomplished by using some rugged, high-speed switching transistors or FETs, which, when alternately turned off and on at a frequency of 60 Hz, will produce a pulsating square wave that resembles something close to an AC sine wave. Now we have something that a transformer can actually use and not overheat. Some shaping circuitry is included to round off the square wave and make it look more like an AC sine wave. Add some "brute force" filtering to get rid of any serious over voltage spikes and further clean up the output and you have the basics of a DC-to-AC inverter.

One word of caution: inverters are not all that efficient. It's only been in the last few years, with the advent of more efficient switching transistors, that inverter efficiency has exceeded approximately 85 percent. Another thing to remember is that



This small 500-watt Cobra inverter powers a small fan and light with ease during an emergency.

inverters are not designed to handle heavy starting current loads like those encountered in AC motors used in air conditioners, refrigerators, freezers, etc. (small AC fans are okay).

Inverters are rated in watts. Standard sizes are 150, 350, 500, 750, and 1000 watts. Each step up the power ladder equates to more money. You can find inverters in the kilowatt range, but be prepared to shell out a bundle of cash.

If you think you need a DC-to-AC inverter, shop around places like Sam's Club, Wal-Mart, K-Mart, and home improvement stores for the best deal. Often after the peak camping/RV season is over you can find inverters at really attractive prices. A 150-watt inverter will adequately power a laptop computer and a printer. A 350-watt device will also power a 40- to 60-watt AC soldering station or small AC fan or low-wattage fluorescent lamp plus the computer gear. Be sure to monitor the battery terminal voltage and recharge the battery as necessary. I would also highly recommend that you use a separate equipment battery (preferably a deep cycle marine or RV battery) to power the inverter rather than rely upon your vehicle battery. If you deeply discharge the equipment battery, at least you'll still be able to start your vehicle.

EMCOMM Power & Light

Speaking of batteries, we might as well discuss the pros and cons of the various large capacity batteries needed for long-term emergency communications in the field. Batteries come in various shapes and sizes. Some are more suited to our EMCOMM situations than others. Here is a brief synopsis of what's available and their proper application.

Lead-Acid Batteries

Standard vehicle and deep cycle marine/RV batteries are officially known as *secondary batteries* and have the advantage of being able to be recharged numerous times. They are of the lead-acid variety and come in a various sizes and current capacities. They work using a process called *electrochemistry*, which is a reversible chemical reaction that alternately produces or stores electrical energy. A good rule of thumb, when looking for a replacement battery for your vehicle, is to pick one with as much cold-cranking capacity as possible that will still physically fit into the battery box of your ride.

Battery Magic

Batteries are made up of individual cells connected in series/parallel arrangements that store an electrical charge, based upon the size of the individual cell plates and the electrolyte in use. All batteries have some kind of electrolyte. In the case of vehicle and marine batteries, this electrolyte is sulfuric acid (H_2SO_4). The individual cells have a positive electrode (or plate) made from lead dioxide (PbO_2) and a negative electrode (plate) made from spongy lead (Pb). These plates are immersed in an electrolyte solution of sulfuric acid (H_2SO_4) and water (H_2O).

The electromotive force (EMF) or voltage that a cell can deliver is determined by the chemical reaction that occurs within the cell. Lead-acid delivers about 2.1 volts per cell, while NiCd delivers about 1.25 volts. The amount of current produced by each cell is directly proportional to the size of the cell and its associated electrodes. The bigger (more surface area) the electrodes, the more current capacity is achieved.

An electrochemical reaction takes place when the sulfuric acid in the electrolyte separates into positive hydrogen ions (H^+) and negative sulfate (SO_4^-) ions. While this chemical reaction is taking place, the lead plate (the negative electrode) begins to release electrons and form positive lead ions (Pb^+), giving this plate an overall negative charge. Some of the negative sulfate ions in the electrolyte solution combine with the positive lead ions on the surface of the negative plate, forming a coating of lead sulfate (more on this later).

The atoms on the surface of the positive electrode (the lead dioxide plate) give up negatively charged oxygen (O^-) ions into the electrolyte solution. The loss of electrons that are carried into the solution by the oxygen ions gives the lead dioxide plate an overall positive charge (Pb^+). Some of the negative sulfate ions will combine with the positive lead ions to form a coating of lead sulfate on the positive plate of the cell.

Negatively charged oxygen ions (O^-) in the electrolyte solution now combine with the positively charged hydrogen ions (H^+) to form water (H_2O). When the cell discharges, the amount of water in the electrolyte solution increases, while the amount of sulfuric acid decreases. This can be directly measured by using a hygrometer, or specific gravity tester. A fully charged secondary lead-acid cell will have a terminal voltage of 2.1 volts

and a specific gravity of 1.23. As the battery discharges, this specific gravity will drop towards 1.0, which is the specific gravity of water. A hygrometer can be a very useful tool to check on the actual condition of the lead-acid battery and its present state of charge. Some of the newer lead acid batteries include a hygrometer on the top of the battery so you can monitor the charge visually.

If some form of load and conductors are connected to the terminals of a cell or a battery (several cells wired together to achieve higher voltages and currents that are available using a single cell) the battery discharges, current flows, and you can power your gear.

This discharge process can be reversed by applying a voltage to reverse the ionic flow through the battery. A DC voltage that is *greater* than the voltage produced by the lead-acid cell is connected between the terminals. In a battery configuration, this voltage will be the nominal *terminal voltage* of the battery. Ergo, a "12-volt" vehicle battery can be recharged using an applied voltage in excess of 12 volts. Normally this is somewhere between 13.8 and 14.4 volts.

During this process, the specific gravity increases, but hydrogen gas is liberated as a byproduct of this recharging. Hydrogen gas is explosive! This gas must be vented off. **WARNING: Always recharge lead-acid batteries with plenty of ventilation.** If you want to see just how destructive hydrogen gas really is, check out a news clip of the crash of the Zeppelin Hindenburg at Lake Hurst, New Jersey, back in the 1930s.

Charging (or recharging) also creates heat. Heat is bad. A fully discharged battery looks, to the charging source, as almost a dead short. When discharged, a battery's internal resistance drops very low (remember that specific gravity thing?). As the charging cycle progresses and the battery starts "taking" a charge, this internal resistance increases, thereby reducing the charging current. However, in the beginning, a deeply discharged battery needs some type of current limiting to ensure that the current capacity of the charging source is not exceeded and the internal workings of the battery don't melt or otherwise become degraded.

The preceding basic description of a lead-acid battery holds true for standard vehicle and marine/RV deep cycle batteries and sealed lead-acid (SLA) or "gel-cell" type batteries, all of which can be used for EMCOMM. While a standard

vehicle battery is used to initially start the vehicle (and then is immediately recharged by the vehicle's charging circuitry), it is *not* designed for the deep discharge associated with use in emergency communications. This is due to the internal construction of the cell plates, which are much thinner than deep cycle marine/RV batteries.

These deep cycle batteries are much better suited to EMCOMM since they are designed for deep discharges with no physical damage to the individual cells. Heavy discharge of a vehicle battery will eventually lead to warping of the cell plates and excessive buildup of sulfates (remember the lead sulfate that is deposited on the positive and negative electrodes inside each cell) on the plates. These sulfates eventually drop off, build up at the bottom of the cell, and will short out that cell, thereby rendering the battery useless. The thicker plates of the deep cycle battery greatly reduce or eliminate this plate warping under excessively deep discharge cycles.

Can you use a standard vehicle battery for emergency communications? Certainly, we do it all the time from our vehicles. Normally, when the vehicle engine is started, the recharging process starts immediately and we seldom see any degradation of the battery. Can you pop a battery out of a vehicle and use it for EMCOMM? Sure. Why not? Just remember, you won't be doing the battery any favors, but, like I said before, all bets off in an emergency situation. Sure, it would be ideal to have a deep cycle marine/RV battery handy for use in emergencies, but that won't always happen. You use what you have and get on with the program (improvise, adapt, modify, and overcome).

If you are limited to using standard lead-acid vehicle batteries for your gear, set up some type of recharging rotation, whereby your on-line battery is replaced with a fresh one, just out of a vehicle. Your partially discharged battery is then placed into a vehicle to be driven and recharged. By monitoring your battery's terminal voltage and specific gravity (remember the hygrometer?) and strictly adhering to a recharging rotation, you should never be out of power for your comm gear.

Vehicle batteries are designed to be quickly recharged using relatively high current. Not so, deep cycle marine/RV batteries, which respond much better to low charging currents. Obviously, this means that the deep cycle batteries are

going to take longer to recharge than the vehicle batteries. If you try to "slam charge" a deep cycle battery (these include SLAs) you will drastically shorten the useful life of the battery. So, there you have some of the trade offs in the world of portable/emergency power.

Sealed Lead-Acid Batteries

SLAs are unique in that they have all the attributes of a standard lead-acid battery, but, due to their construction and packaging, can be used in applications where a regular lead-acid battery cannot. Typically, you'll find SLAs in emergency lighting, surveillance systems, computer UPS systems, and hospital/EMS medical equipment. They are normally physically smaller with the associated lower current capacities, but they can be placed on their side or inverted, which is not possible with standard lead-acid batteries. Since they are sealed, strict charging regimens must be maintained, lest too much current be used causing the electrolyte to start gassing off and the battery to explode!

The medical equipment repair community regularly removes perfectly good and serviceable SLAs from their equipment simply because it is required by state/federal laws or equipment manufacturer's instructions. A great source of cheap or free SLAs is your local hospital equipment repair shop. Many hospitals have in-house electronic technicians you can contact to get their "pulls" on a regular basis. Once you explain that you are an emergency communicator and are in need of some SLAs, most likely they will be readily agreeable to giving you a few batteries that they will ultimately either throw away or turn in for recycling. Ditto for the security folks. Alarm systems, video surveillance, and recording systems all utilize SLAs. Get to know the techs at the local alarm company and maybe you'll get lucky and snag some freebies.

The Care And Feeding Of An SLA

A gel-cell or SLA provides roughly 2.4 volts per cell at a fully charged state. SLAs are very unforgiving of overcharging, and damage can result due to overcharging or trickle-charging for extended periods. While most secondary batteries require a "constant current" regulated charger, the SLA requires a "constant voltage" charger. A charger specifically designed to recharge gel-cells will maintain a safe charge current until the cell voltage reaches 2.3 volts/cell. This

equates to 13.8 volts for a "12-volt gel-cell." The charge current is then tapered off until 2.4 volt/cell is reached. At this point the battery may be safely maintained at a float charge of 2.3 volts/cell using a charger specifically engineered for gel-cells.

Yes, SLAs are a bit more complicated to work with but once you understand how to deal with them they are a tremendous source of emergency power obtainable at minimal cost, sometimes for free!

Obviously how you handle your EMCOMM station's power distribution is up to you, but I certainly would consider the West Mountain Radio *RIGrunner* or possibly one of the several DC power strips offered by MFJ Enterprises. As a matter of fact, a "power siphon" can be easily made using one of these DC power strips and affixing large alligator clips (suitable for clamping onto the terminals for a lead-acid battery). Take the "power siphon," clip the input leads to a deep cycle battery, and then start plugging your gear into the power strip. Now that is simple power distribution.

Until next month, remember: Preparedness is *NOT* an option. ■

**TERRORISM FORCES
US TO MAKE A
CHOICE. WE CAN BE
AFRAID. OR
WE CAN BE READY.**

READY

WWW.READY.GOV

1-800-BE-READY



Lee Electronics
Scanners, SW, FRS and More:
AOR & Cobra Bearcat ICOM
SANGEAN GRUNDIG Uniden
I-800-578-6006
Tech: (724) 275-5822
www.LeesElect.com



POWERPORT
BagBattery
For the price of a simple 7AH battery, we will give you an 8AH battery in a heavy-duty nylon padded case to protect it and carry it safely wherever you wander. Only \$33.95
800-206-0115
www.powerportstore.com



The Ultimate in Multi-Receiver Audio Control
All at the Push of a Button!

NCS brings you the ultimate in multi-receive audio control with unprecedented functionality. The Multi-Rx allows you to connect up to 6 receivers, transceivers, scanners or any other speaker audio source and you won't need all those speakers - you need only 2!

In the *Normal* mode individual radio audio can be routed to the left, right or center (both) speakers. In the *Spatial* mode each radio is assigned a position in the sound field making each radio sound like its coming from a different position. If you hear something you want to focus on simply press the center button for the radio you want to monitor and the audio is brought to the center and amplified 3 dB making it the dominant audio in the sound field.

A *stereo amplifier* provides more than ample audio to speakers or headphones. AND you can use speakers, headphones or both simultaneously (selectable).

NCS-3230



8.5"W x 6.2"D x 3.3" H
Multi-Rx

Provisions for control of an external recorder are provided making it easy to record any or all audio channels using Manual or VOX operation.

Busy lights are provided for each radio for quick ID of active audio channels. If using the Multi-Rx with a transceiver, muting functions are provided to mute all radios during transmit. AND there's much, much more....See our web site or contact us for more info.

Take Your Monitoring Hobby to a New Level Get Your Multi-Rx Today!
New Communications Solutions, LLC
Toll Free Tel: (888) 883-5788 Email: ncsradio@ncsradio.com
See Our Web Site for Details: www.ncsradio.com

computer-assisted radio monitoring

by Joe Cooper,
carm_popcomm@hotmail.com

Audio Digital Recording Column—Part II

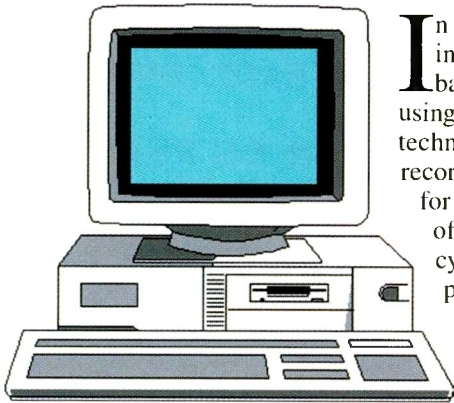

In last month's column I introduced you to the basics of audio recording using both analog and digital techniques. While analog recording has been with us for a long time now (think of Thomas Edison's cylinder recordings, long playing records, and tape recorders), many people today are now switching over to digital recording.

Digital's growing popularity is largely due to the greater control you can have over how you record and the greater dynamic range of sound when you play it back. Also, digital recordings don't degrade as quickly as analog recordings. Remember when records and audiotapes used to "wear out" with use? Both would start to get hiss, crackles, and pop over time. In fact, a lot of audio engineers' time and effort went into developing special technology to prevent that degradation from happening.

Remember how top-end record players used special balanced weights to make the weight of the arm and needle as light as possible when touching the grooves of an LP? Or how audiotapes came in various makes of recording material in an attempt to keep background hiss to a minimum, which was then reduced even further through the use of special audio filters? That's not the case with digital recordings. Now you have the potential for an extremely long lifetime for a digital recording, which will sound exactly the same as the first time it was played, no matter how many times it is listened to.

These characteristics (precise recording control, good output sound and longevity) make digital audio particularly popular among people who record signals off the air for radio monitoring purposes. Digital is the perfect medium for radio monitors who want to not only record, but also preserve what they monitor so it can be enjoyed many years in a form that's as close as possible to the original sound that came out of the radio's speakers.

Yet there is more to digital recording than simply good quality reproduction.

In most cases, the signals being monitored aren't broadcast quality; they can be distant, full of interference, or otherwise difficult to hear. What digital recording techniques offer is a means of not only capturing the signal, but also of making it easier to listen to by improving the signal-to-noise ratio of the recording.

This means that you hear more signal than background noise and static because the recording technique doesn't add any extra noise, which is generally the case with analog recordings. This removal of extra noise when recording can be further enhanced with other digital filtering techniques, such as Digital Signal Processing (DSP) and digital band-pass filtering (removal of a range of frequencies above and below the center frequency through software programming).

This month I'm going to look at some of the basic digital recording techniques available to you through your home computer. Remember that to make such recordings, you'll need a working digital sound card installed on your computer. You'll also need a means of hooking up your radio's sound output to either your microphone or line-in inputs on that sound card. Lastly, you'll need audio speakers to hear the results.

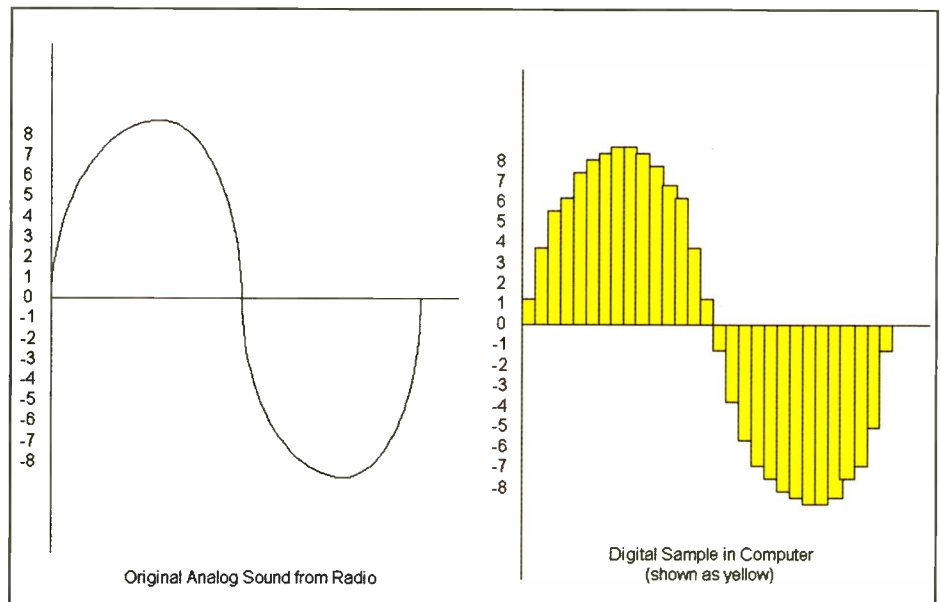

An analog sound wave is made up of two basic components: frequency and volume. You see that with the sine wave on the left. On the right is a representation of how your computer samples that sound wave. Rather than volume, the dynamic range of the sound is represented by bit-depth (in this case 8 bits), and the frequency is sampled several times a second (represented by the yellow bars). Those yellow bars would actually be a series of binary numbers (zeros and ones) in your computer. When you play back the digital recording, information contained in the binary data would be used to re-create an approximate representation of the original analog sound wave. In general, the greater the bit depth and sample rate you use to record the original sound, the more accurate the reproduction will be when you play it. However, there are limits to amount of bit depth and sample rate that you can use, which are explained in the column.

Getting Started In Digital Recording

There's more to digital recording than simply plugging your radio's audio output into your computer's audio input, recording the signal to your hard drive with a digital recorder, then listening to the results. Frankly, if you do that without some background knowledge of digital recording, what you eventually hear may disappoint you because what you're listening to coming out of your radio's speaker (or headphones) is *analog sound* which contains every part of the signal, including noise.

While it may not be music to some people's ears, the fact is that such sound has many different frequencies and harmonics, which your ear and brain can use to make sense of what you are hearing. However, when you use your computer to record it, the result is a *sampled* source of sound, so parts of it are actually missing. Therefore, when you play back digital recordings, what you're listening to is not the original sound you heard, but an approximate representation of it. Depending on how sensitive your ears are, your hearing may be able to discern the fact that there are missing sounds.

For some people this isn't a problem, in fact, it can be a very powerful tool in overcoming some of the difficulties encountered with radio monitoring. Consider how much better a radio signal could be if you could remove background noises. That is what digital recording can help you do, and much more.

But before you make a digital recording, you must first make a decision as to how closely you want the final result to represent what you originally heard coming out of your radio. There are two reasons for this. First, the quality of sound you create will depend upon the type of digital recording technique you use. There are several techniques available, each producing its own level of audio fidelity (that is the quality of reproduction that is achieved). Second, in general, the higher the quality of the digital sound recording you make, the larger the resulting file. As a rule of thumb, the best recordings result in very large computer files because they have the most digital information. As I'll show you, however, there are new digital recording techniques that can compress large computer files into smaller ones without noticeably reducing quality.

In this and future columns I'll discuss

the various types of popular audio files that you can create, specifically WAV, MP3, and WMA. As you'll see, each file type produces a particular audio quality, which can range from hi-fidelity sound (as produced by a top quality CD) to what you would hear coming from a cheap AM radio.

First, let's look at why there's such a wide range of audio outputs in digital recording so you can choose the best output method for your particular radio-monitoring situation. This knowledge will also help you properly set up and control the digital recording software you are going to be using.

Digital Audio Quality

You create a digital audio file through "sampling" an analog signal by using computer hardware and software that converts each sample into a sequence of digital numbers (zeros and ones to be precise).

There are two important components to this sampling: the sample rate (the number of times that a sample takes place over a fixed period) and the bit depth (the amount of information that's captured in each sample). With some digital recording software you can control the sample

rate and the bit depth, so it is important to understand what these components are and how they are used.

The sample rate determines the highest frequency that can be captured from the analog signal. As a rule of thumb, the highest frequency that can be preserved when making a digital recording from an analog source is always less than half the sampling rate. So, for instance, the 44.1-kHz sample rate used by CD audio can capture frequencies up to about 20 kHz. If you sampled at 32 kHz, the upper audio range is reduced to roughly 16 kHz. If you went all the way down to 4 kHz, the upper audio range would be about 2 kHz.

You can actually increase the sample rate with some digital recording software, but frankly it is unlikely that anyone, except maybe your dog or cat, is going to hear the results. Likewise, if you're recording something with an audio dynamic range much less than 20 kHz (for example, SSB, RTTY, or CW signals), you gain nothing but noise and static in your recording by using a high sample rate—not to mention large computer files of your results.

The digital audio bit depth used in digital recording determines how many different levels of volume you can capture from the original analog signal. Here the

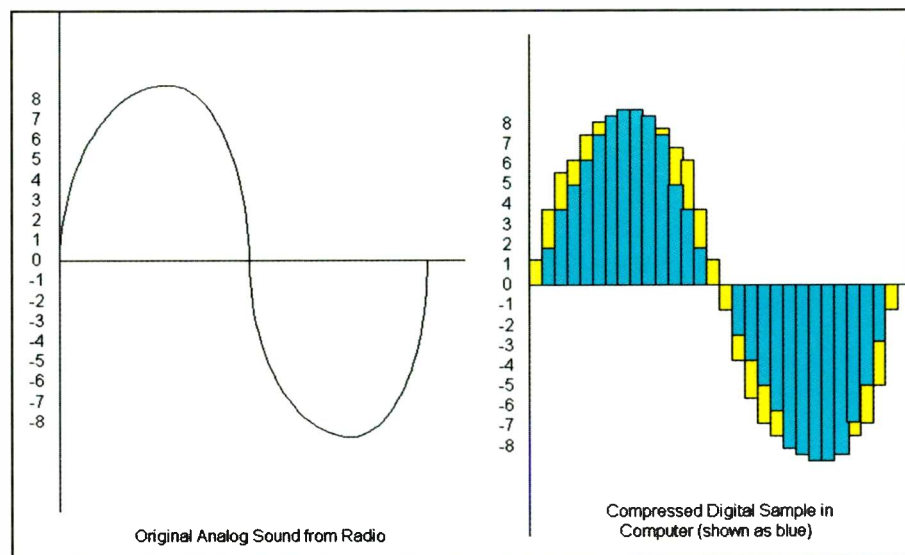

This picture illustrates the difference between an uncompressed and compressed digital recording. The blue bars show the compression, which has eliminated some frequencies (the upper and lower), while leaving the middle frequencies alone. Other frequencies that are not important have been reduced or eliminated as well. When the human ear hears the results of this compression the missing parts will not be missed, as they are not normally heard anyway. In this method of compression, the removed information reduces the amount of information stored, making the file smaller. This is a simplification of the actual methods used in most audio compression, which use many different ways to mask, eliminate, or reduce the information stored in a digital file in order to reduce it to its maximum amount without losing noticeable sound quality.

greater the number of bits, the greater the dynamic range that can be captured by the digital version of the analog signal. The standard today is to record with 16 bits. This means that each time an analog audio source is sampled, it can be divided into 65,536 levels (2 to power 16), which translates to a dynamic range of 96dB. In other words, 16 bits can capture a wide range of sound, from almost pure silence to 96 dB. What that means is that you can hear extremely minute differences in sound between signals. Thus, a 16-bit depth will let isolate one signal from another with greater ease by enabling you to distinguish subtle differences in volume.

This is where digital really begins to outshine analog, which cannot offer the same dynamic range, at least not without going to a very expensive radio. The only problem you face with good digital recordings that sample at 44.1 kHz and 16-bit depth is their resulting size. For example, a three-minute recording at that rate and depth can result in a 30-megabyte file.

Some of you may have the storage capacity to manage such digital audio recordings, and you may wish to make them because of the better quality. However, not everyone wants or needs that level of recording quality, especially if you are monitoring radio signals that aren't high fidelity to begin with.

So let's take a look at each audio file

type, with an example software program that you can use to make a recording with.

WAV files

WAV (pronounced wave) files are complete and uncompressed digital samples of a sound source. They're generally a high-quality format for storing music or sound, but are very large because of the amount of information needed. For instance, a stereo (two-track) 44.1-kHz sample (44,100 slices per second) with 16-bit technology (65536 levels) requires 176 kilobytes of information per second. This is why early digital sampling musical instruments could only sample for a few seconds—they simply didn't have the memory storage capabilities. Nowadays, however, it's possible to store large wave files onto hard disk or CD. A 74-minute wave file takes up 650 MB of storage space and 80 minutes can be stored on 700MB CD media.

MP3 Files

This is a fairly new method of digital recording that has gained a lot of popularity recently. Its main characteristic is that it produces very high-quality sound while creating a computer file that is only 1/12 the size of a WAV file. This is possible because, rather than trying to capture everything contained in the sound, MP3 only records the information the human ear can actually hear. So when you record with MP3 you get a very good approximation of the sampled sound. It's so good, in fact, that when the sound enters your ear and is processed by your brain, you think you're listening to something very close to the original.

So with MP3s you get very nice sound quality and very small files (rather than recording a maximum of 80 minutes of sound on a conventional CD, you can now store 12 times as much, or roughly 960 minutes). One problem for some people, however, is that MP3s require a very powerful computer CPU to produce the best sound. The reason for this lies in the complex method it uses to encode and decode sound.

When using MP3 to either record or play on a computer without a fast processor, some people find they are limited to the number of programs they can run simultaneously. Thus, using an MP3 recorder (or player) while using a software program to control a radio or run a log program may cause the computer to run very

slowly, or even lock up completely.

There are other considerations as well that will be discussed after looking at the next digital recording file type.

WMA

WMA or Microsoft Windows Media Audio is beginning to replace MP3 in some cases. It is a well-designed audio recording method that can handle all types of audio content. You can choose from a range of speech-only audio, recorded with a sampling rate of 8 kHz, to 48 kHz higher than CD quality stereo music. WMA is also very resistant to degradation due to loss of data while recording because it does not use temporary memory, as MP3 does, to deal with a wide range of frequencies.

Most important for many who choose this standard is that it does not need a powerful CPU to record or play back. This allows you to run multiple software programs while running WMA software. Also, the compression method used to create audio files requires much less disk space for storage than MP3. Finally, WMA provides much clearer sound with greater tonal distinction than other recording methods using compression.

Put plainly, WMA offers a combination of good sampling rate with good bit depth to produce better-sounding content across all supported bandwidths. It also provides both high-quality mono and stereo audio, and so is a very good choice for radio monitoring.

There Is No Free Lunch

At this point you have to start asking some serious questions about what your recording priorities are going to be. In recording using compression techniques, as with everything, you don't get something for nothing. No, I'm not talking about bootlegging music by copying it off the air, but rather what you gain or lose by using a compression technique to record a radio signal.

For instance, MP3 works by removing parts of the sound that you hear, but that may be critical for you when you are trying to identify a weak or distorted signal. If you're listening to a shortwave broadcaster with a strong signal, or strong local signal on your scanner, then MP3 may be what you are looking for. On the other hand, if you're trying to use digital recording to pick out a very weak signal with lots of background noise, then you're

**Better
Than
Ever!
CQ VHF
is here!**



The all-time favorite U.S. magazine for the VHF/UHF enthusiast **CQ VHF** - is here to serve you. You'll find more meaty reading for the really serious VHFer than ever before. That's what our surveys told us you wanted, and that's what you'll get.

Take a moment now and take advantage of our special offers on our one, two or three-year subscriptions. You'll save money and receive fast home delivery!

1 yr - \$25.00 2 yrs - \$45.00 3 yrs - \$65.00

Canada/Mexico 1 yr \$35.00, 2 yrs \$65.00, 3 yrs \$95

Foreign - 1-yr \$38.00, 2-yrs \$71.00, 3 yrs \$104.

Payable in U.S. dollars

MasterCard/Visa/American Express/Discover Accepted

Mail your order to: **CQ VHF Magazine**
25 Newbridge Road, Hicksville, NY 11801
Subscribe on line at www.cq-vhf.com
FAX your order to us at 516 681-2926

Call Toll-Free 800-853-9797

Buy Police Call 2004 and get a CD at no extra cost!

POLICE CALL

2004 EDITION

COMPLETELY REVISED THROUGH JULY, 2003

- With Fully Searchable Nationwide CD.
- 20,000 Codes and Signals.
- Trunking Talkgroup IDs.
- Includes U.S. Government, Rail & Air.
- Illustrated 10-Page Listener's Guide.

GOT A SCANNER? GET POLICE CALL

At your scanner dealer and all Radio Shack stores.
Visit our web site at www.policecall.com



More People Buy **POLICE CALL** Than All Other Frequency Guides (VHF/UHF) Combined.

going to want as much data as possible, so WAV may be your best bet, with WMA being a close second.

This leads us to the real point of digital recording for radio monitoring: it's a whole new field to experiment with. Nobody has the ultimate scoop on what is the best method. Frankly what I've been describing here are the most popular non-professional methods of digital recording and that are the easiest for most people to use. It is a good starting point as we continue to explore computer-assisted technology in the space of this column.

In this regard your feedback on the use of these different modes—both positive and negative—is really important. What do you find works best for your type of radio monitoring? The only way to find out is by doing what radio hobbyists have done since the days of crystal radio sets and earlier: experiment, experiment, and experiment some more. Then share your results with others, which you are welcome to do through this column.

Next Month

Next month I'm going to—finally—introduce you to some digital audio

recording software and give some pointers on some audio playback software as well, specifically software for those who want to record what they hear on their monitoring radios. I'll be looking at those software digital recorders that are easy to use and have the capability of starting and stopping recording at specific times.

Even if you don't have a monitoring radio that can be directly controlled by a personal computer (e.g., many of the popular portable types), these modern digital radios have built-in programming capabilities. This means you can set up your radio to tune into a specific time and frequency, and have your digital software turn on and record at the same time. This way, if you're at work or asleep at night, you can still capture the signal you want (depending upon atmospheric conditions and other factors). Of course, you'll need to connect your radio's audio output to the audio input of the computer's sound card (line-in or microphone) to create the actual recording.

Please e-mail or write to me with ideas, comments, and suggestions. Please note that I have a new e-mail for the column, carm_popcomm@hotmail.com.

Don't use joe@provcomm.net because it's becoming unusable due to the amount of spam I receive each day (well over 100 junk e-mails). The hotmail account offers some protection from that and is a dedicated e-mail address for the column that makes it easy for me to sort through.

I also first announced that the hotmail address would be carm_popcomm@hotmail.com. I'll be using that one for a short while, but in about a month from this publication I'm shutting it down. So please use the one listed above (with the two "m"s). Thanks in advance for your cooperation.

You can still send me regular mail (and many of you are) at my mailing address: "Computer-Assisted Radio Monitoring," C/O Joe Cooper, PMB 121, 1623 Military Rd., Niagara Falls NY 14304-1745.

Remember, I can't answer general questions about computers, software, or operating systems, but I'll do my best on questions about the content of the columns or computer-assisted radio in general.

Thanks again and I hope that the information provided here will help you get the most out of your computer and monitoring radio than you ever thought possible ■

Replicating Atwater Kent's "Tonebeam" And More

This month's lead material is contributed by Ed Engelken. Ed has devised an innovative and practical solution to a stumbling block facing many vintage radio enthusiasts: a means for replicating neon tube "Tune-A-Lite" tuning indicators! I'm indebted to Ed for sharing this information with the collecting fraternity.

Atwater Kent Model 480 Restoration

by Ed Engelken

After nearly two years of effort, my restored Atwater Kent Model 480 was almost complete—except for a missing Tonebeam. The Tonebeam is an early tuning indicator used in a number of high-end Atwater Kent models from 1932 to 33. The advent of Automatic Volume Control (AVC) generated interest in tuning indicators as an aid in correctly tuning a station for maximum audio fidelity. Also, a flashy tuning indicator is a great sales "hook." Philco and Zenith used tuning meters much like the S-meters used in communication receivers. These early tuning meters were given names like "Shadowmeter" or "Shadowgraph," but the devices were basically mechanical meter movements.

Atwater Kent, FADA, Kolster, Sparton, and a few others used a device manufactured by the Duovac Radio Tube Corporation of Brooklyn, New York (Figure 1). Duovac called their device the Tune-A-Lite, but Atwater Kent marketed it as a Tonebeam, and FADA called it a Flash-O-Graph.

The Tune-A-Lite is a specialized neon-filled glass tube about four inches long and 1/2 inch in diameter. The tube contains one electrode that extends the length of the tube and, depending on the version, one, two or three shorter electrodes used to control the glowing neon column. Atwater Kent literature described the Tonebeam operation in these words: "The Atwater Kent Tonebeam is a neon-light column that indicates visually when the set is tuned correctly to resonance with the incoming signal." The neon-orange column of light would rise to a peak as resonance was reached and drop to a low level when the set was tuned between stations.

The Tonebeam was only used in 1932 and 1933 models, and was apparently discontinued because of the devices very short operating life-span. Photo A shows the original Tonebeam display tube from my Atwater Kent. The inside of the tube is coated with a silver-black deposit of metal "sputtered" from the electrodes. The short life of the tubes and the introduction of the 6E5 Electron Ray tube (Tuning Eye) in 1935 signaled the end of the Tune-A-Lite devices.

Finding A Replacement Tonebeam

Given the short production period, and their short operating life span, the prospect of finding a NOS Tonebeam is slim. An unused Tonebeam would be a collector's prized possession, but

Figure 1. This 1931 advertisement for the Duovac Tune-A-Lite touted its advantages as a sales tool.

putting it into operation in a radio would soon ruin it. My only solution was to simulate the Tonebeam using available components. I had two choices: build a light column using orange LEDs and a couple of LM3914 Dot/Bar Display Drivers, or use currently available neon lamps to simulate the Tonebeam column. I just couldn't get excited about using solid-state circuitry in a 1932 vintage radio, so I decided to go with the neon lamp approach.

Designing The Replacement

The Tonebeam's viewing window in the Atwater Kent 480 measures two inches high and 3/16 inches wide. I found that eight NE-2 neon bulbs would just fill the window. The next step was devising a circuit to operate the NE-2 bulbs in a manner simu-



Photo A. The defunct Atwater Kent Tonebeam is shown with its socket and the eight neon lamps that were used to replace it.

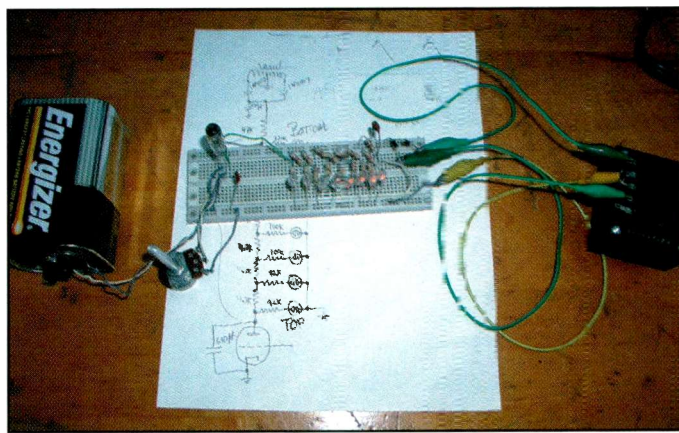

Photo B. A breadboard version of the Tonebeam circuit was used to refine the component values.

lating the action of the Tonebeam. The circuit I devised is shown in **Figure 2**.

This circuit uses a 6C4 triode tube to “pull down” the end of a voltage divider, causing the bulbs to operate in sequence. A large negative bias on the grid of the

6C4 will cut-off the tube, illuminating all the neon bulbs at equal brilliance. As the bias is reduced, the 6C4 will sink current through the voltage divider, and the bulbs nearest the 6C4 plate will get dim, and then extinguish, in sequence as more and

more current is drawn by the 6C4. With the bias reduced to zero, only the bottom bulb remains lit.

Note that the high-voltage supply for the voltage divider (and NE-2 bulbs) is full-wave rectified, but unfiltered. This is

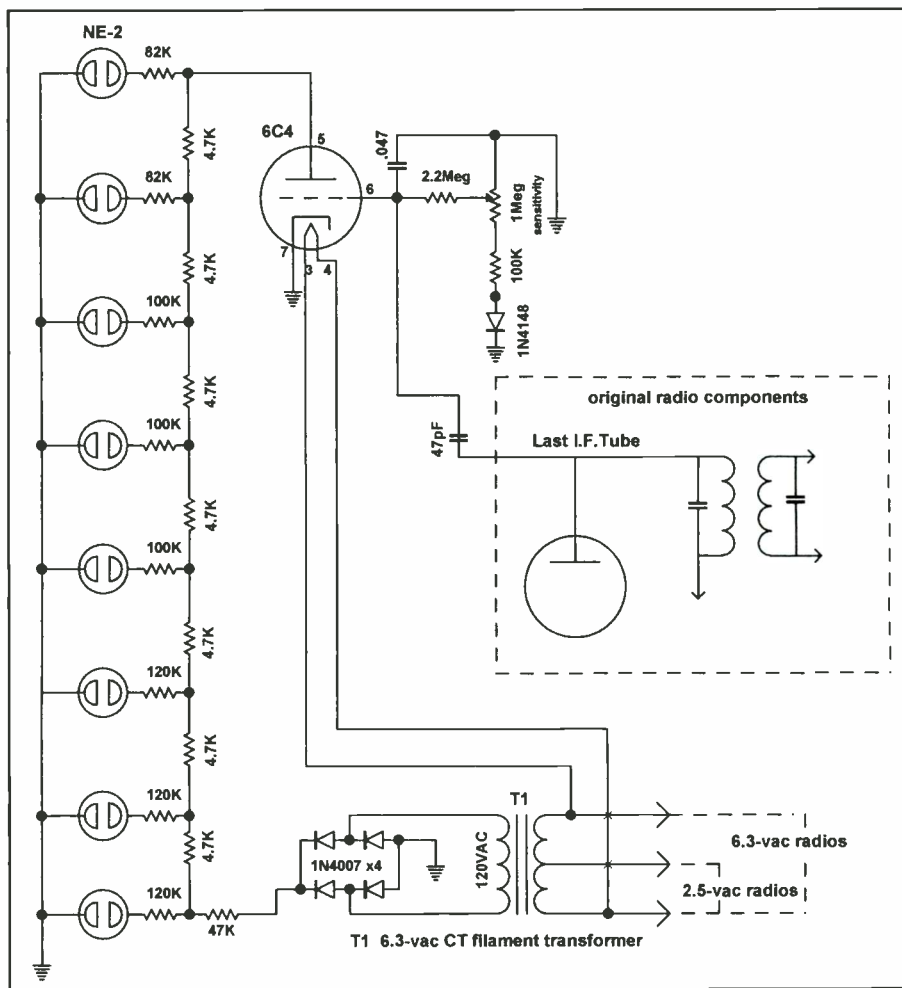

Figure 2. The schematic diagram of the Tonebeam replacement.

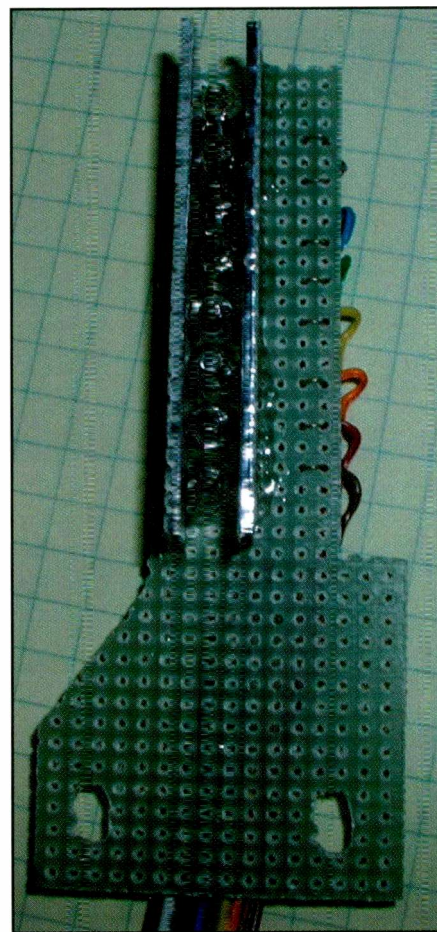

Photo C. The Tonebeam display consists of eight neon bulbs sandwiched between aluminum foil-covered pieces of perf board.



Photo D. The Tonebeam display before it was mounted behind the Tonebeam window in the dial escutcheon.

Photo E. The Tonebeam display is installed in the escutcheon and the remainder of the circuit (contained on a small perf board) will be mounted under the chassis.

important because the neon bulbs require about 90 volts to light, but, once lit, the voltage must decrease to about 65 volts to extinguish them.

So, if well-filtered DC is used, the illuminated column will tend to stick in the

“peak” position due to this hysteresis effect. Using pulsating DC causes the illuminated bulbs to blink on and off 120 times-per-second, eliminating the hysteresis. It’s also important to derive the operating voltage from a relatively low-

impedance source to keep the voltage fairly constant as the bulbs operate. It’s a good idea to breadboard the circuit before doing the final hardwiring. **Photo B** shows my early breadboard version of the circuit, which uses a Raytheon CK5703



Photo F. The Atwater Kent is tuned to WOAI, a local 50-kW broadcast station, bringing the display to full height.



Photo G. A weak signal manages to illuminate three of the neon bulbs.



Photo H. The completed Atwater Kent Model 480 has a beautiful cabinet.

Lamp	Volts	Amps	Candle Power	Bead Color	Base	Bulb Style
40	6.3	0.12	0.5	Brown	Miniature Screw	T-3 1/4
40-A	6.3	0.15	0.5	Brown	Miniature Bayonet	T-3 1/4
41	2.5	0.5	0.5	White	Miniature Screw	T-3 1/4
42	3.2	0.5	0.75	Green	Miniature Screw	T-3 1/4
43	2.5	0.5	0.5	White	Miniature Bayonet	T-3 1/4
44	6.3	0.25	0.8	Blue	Miniature Bayonet	T-3 1/4
45	3.2	0.5	0.75	Green	Miniature Bayonet	T-3 1/4
46	6.3	0.25	0.8	Blue	Miniature Screw	T-3 1/4
47	6.3	0.15	0.5	Brown	Miniature Bayonet	T-3 1/4
48	2.0	0.06	-	Pink	Miniature Screw	T-3 1/4
49	2.0	0.06	-	Pink	Miniature Bayonet	T-3 1/4
-	2.1	0.12	-	White	Miniature Screw	T-3 1/4
49-A	2.1	0.12	-	-	Miniature Bayonet	T-3 1/4
50	7.5	0.2	1.0	White	Miniature Screw	G-3 1/2
51	7.5	0.2	1.0	White	Miniature Bayonet	G-3 1/2
-	6.5	0.4	1.5	White	Miniature Screw	G-4 1/2
55	6.5	0.4	1.5	White	Miniature Bayonet	G-4 1/2

This table gives the technical spec's for various pilot lamps you'll likely encounter while working on vintage equipment.

sub-miniature tube instead of the 6C4 used in the final circuit.

One thing I learned is that all NE-2 bulbs are not created equal. The bulbs all have different voltage thresholds, probably due to slight differences in electrode spacing and gas pressure. When I first operated the breadboard circuit, some of the bulbs operated out of sequence. Swapping the bulbs around solved the problem. Therefore, it is necessary to test the bulbs in the circuit and get them in the proper order before soldering them in. **Photos C, D, and E** show the construction details. Nothing is critical about the circuit, so the parts arrangement can be adjusted as needed to fit your particular radio.

Interfacing The Circuit To The Radio

Designing a circuit to operate the neon bulbs is one thing, but getting the bulbs to respond to the received signal properly is another. My Atwater Kent doesn't have a diode detector generating the usual AVC voltage that is found in later receiver designs. The A-K uses a triode tube employing plate detection, and a separate "control tube" is used to implement the AVC function. My solution was to add a 1N4148 silicon diode to develop an adjustable AVC-like voltage to feed to the grid of the 6C4. The 1-

Megohm pot sets the sensitivity of the Tonebeam. The sensitivity pot should be set so the strongest local AM station illuminates all eight neon bulbs.

Power for the circuit is derived from a small 120- to 6.3-volt filament transformer, connected backwards so the filament supply in the receiver powers the 6.3-volt winding and the 120-volt winding supplies the power for the neon bulbs. For radios with 2.5-volt tubes, like my A-K, apply the 2.5 volts between the center-tap and one side of the 6.3-volt winding. This results in only 5 volts for the 6C4 heater, but that is sufficient given the light duty requirements. For radios with 6.3-volt tubes, apply the 6.3 volts across the entire 6.3-volt winding. If you can't get proper action of the display by adjusting the sensitivity control, try using a different value for the 47K resistor—something between 33K and 56K should work.

Does It Work?

Photos F and G show the new Tonebeam replacement in action. No, it isn't perfect. The NE-2 neon bulbs do have a discrete look, but the top illuminated bulb does gradually brighten or dim as the column rises or falls, creating a continuous change; it's definitely a functional tuning indicator and the color of the display is correct. The simulated

*Tonebeam adds interest to the otherwise plain-Jane Atwater Kent dial. **Photo H** is the finished Atwater Kent Model 480 in our living room. It looks good and it sounds great!*

Restoration Tips

Here's some practical advice offered by vintage radio enthusiast Fred Nachbaur in an Internet posting:

Tired of those #47 lamps burning out? These are rated at a life expectancy of 3,000 hours, but can be significantly less if the voltage is even slightly above the rated 6.3 volts. Use a #1847 instead. It's rated for 5,000 hours, and has the same voltage/current rating (6.3 volts at 0.15 amps), and the same bulb and base style. I can barely tell the difference in brightness if the two are lit side by side; it's unlikely that I could tell in a blind test (pardon the pun).

Going a step further: if you can tolerate a bit less light (about the equivalent of one f-stop) and don't mind it a little more orange in color, use the #755. It too has the same voltage and current rating as the #47, but is rated for a whopping 20,000 hours typical life expectancy!

Fred offers some good advice. Also, if you collect *boatanchors* (vintage tube based SWL or Ham gear), you might consider using 1847 or 755 lamps in lieu of the 44 pilot lamps often found in this style equipment. The 44 is similar to the popular 47 pilot lamp, except that it draws more current and runs much hotter. Some early receiver dials and S-meter dial scales show heat damage after years of exposure to the heat generated by these lamps, especially if they were positioned too close to the dials! Pinball service folk routinely replace 44 lamps with 47 because of the heat issues, and I've seen where some prefer using 1847 or 755 lamps. A few hams feel the additional light output from the 44 lamps is worth the tradeoffs, however.

On another note, most 47 lamps seem to be Pacific Rim imports, with especially short operating life spans—typically two-thirds of what one would expect from a NOS quality brand. It pays to search for NOS American made dial and pilot lamps, especially for those sets where the dial lamps are in awkward and difficult to reach locations.

In closing, refer to **Table 1**. It presents data for the more popular pilot lamp types you'll encounter in vintage radios. ■

Favorite Radios—A Trip Down Memory Lane

You may remember back in February, we ran the favorite radio pictures sent by readers in response to our October 2002 anniversary celebration. There were lots of responses to our request for input, some coming in as recently as just a few weeks ago, which led me to go back and take another look. There are lots of memories out there, and I hope you'll find something to bring back a few memories of your own.

We asked you to send in a photo of your favorite radio—not necessarily the best one you owned, or the one with the most capabilities, but your favorite for whatever reason.

Several of you sent pictures, which was fantastic. Unfortunately, many of them were too low quality for magazine printing, and some were duplicates. If you sent one, please accept my thanks, even if I haven't used it here! With that, let's take another look at some of your favorite receivers.

The AOR handhelds are also very popular. Representing the high end of the price range, and probably the high end of performance, the AOR 8000 series deserves a place of respect. The 8200 (right) is a vast improvement over the 8000's difficult-to-use interface, but both are excellent handheld receivers. →



← If you were in an area that had switched to one of several trunking systems, this radio or its predecessor were really music to your ears. The Uniden trunktrackers marked a new era in scanning with the ability to follow trunked radio systems.

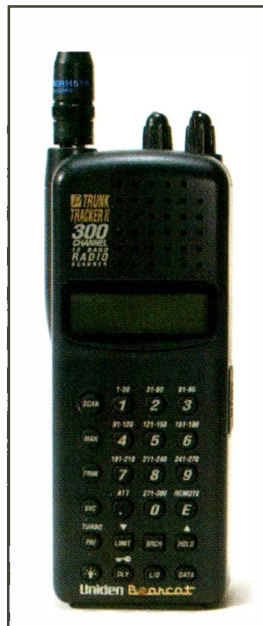

The AR-3000 was an excellent communications receiver before communications receivers were popular for scanner enthusiasts. Its operation as a scanner was not all that great, but it had probably the hottest receiver of its day. These, too, still have quite a following among vintage scanner traders.

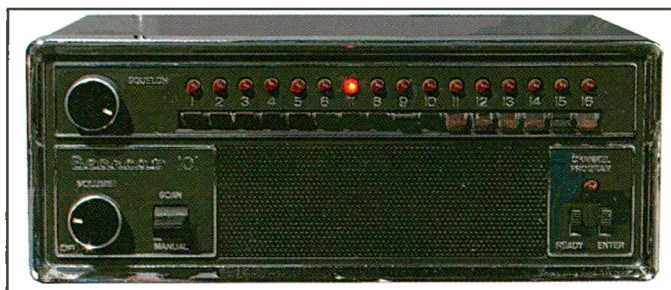

Many of you wrote saying this receiver was your all-time favorite. If you were scanning when this radio came out, you probably have fond memories of it, even if you never owned one. This radio marked the end of crystals for frequency control. Every time you wanted to change a channel on a crystal-controlled radio, you had to buy another \$5 crystal for the right frequency. The BC-101 was the first programmable scanner from Bearcat—the leader in the industry at the time—to hit the mass market. You programmed this receiver by setting the switches up or down to a preset code for each frequency. Not quite the keypad punch-in stuff we have today, but a major improvement!



Before radios scanned, there were the tunables. This receiver always brings lots of comments. If you're a regular reader, you'll know this was my introduction to the world of VHF/UHF monitoring. If it wasn't for this radio, you might not be reading this column!



We've come a long way from crystal-controlled four-channel models to multi-trunking receivers that can be programmed by computer. How many can you name? Pictured here, from left to right, are the RadioShack Pocketscan, Regency HX-1500, Realistic PRO-34, Sony PC Control scanner, Realistic PRO-43, AOR AR-8000, Uniden BC-245, and Realistic PRO-92).



This little base/mobile scanner was quite popular, too. The PRO-2032 was in the RadioShack line for quite a few years. It's a very convenient and affordable conventional scanner in a base station format.

The PRO-43 always inspires debate when you talk about the history of the handheld. Probably one of the first truly useful keyboard-programmable receivers, it enjoys a lot of popularity to this day. It also has its share of detractors, however, as the front end of the receiver was prone to overload in areas of high signal strength.



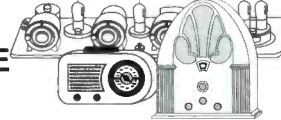

I was a bit surprised by the number of votes for this receiver since it's relatively new. But it sure is popular. I did get the feeling from several of your letters that perhaps this was your first scanner—which is always a favorite for anybody. Made by GRE for RadioShack, this receiver is a great conventional scanner that can also follow trunked radio systems. Some people prefer the way its trunking system works to that of the Uniden radios.

FREE SAMPLE COPY! 

ANTIQUE RADIO CLASSIFIED

Antique Radio's Largest-Circulation Monthly Magazine

Articles - Classifieds - Ads for Parts & Services
Also: Early TV, Ham Equip., Books, Telegraph, 40's & 50's Radios & more...
Free 20-word ad each month. Don't miss out!

 1-Year: \$39.49 (\$57.95 by 1st Class) 
6-Month Trial - \$19.95. Foreign - Write.
A.R.C., P.O. Box 802-T14, Carlisle, MA 01741
Phone: (978) 371-0512; Fax: (978) 371-7129
Web: www.antiqueradio.com

LOOP ANTENNA

The best tabletop AM broadcast antenna. Loops for 50 KHz to 6-MHz plug into amplifier. Free Catalog.



Model LA-1 Loop Amplifier \$135
530-1700 KHz Loop \$135

 + \$6 S&H Tax. in Calif. 

 **PALOMAR**®

BOX 462222, ESCONDIDO, CA 92046
TEL: 760-747-3343 FAX: 760-747-3346
email: info@Palomar-Engineers.com
www.Palomar-Engineers.com

Full 800 MHz Scanners

NEW! AOR AR-8200MKIII

Wideband portable receiver

- 0.5 to 3000 MHz continuous. (unblocked)
- NFM, WFM, AM, WAM, USB, LSB & CW
- Alphanumeric memory identification
- Spectrum scan
- Ni-MH Battery
- Flexible dynamic memory
- Optional CTCSS & Extra memory boards

\$649^{us}

ALINGO DJ-X3

Credit Card Wideband portable receiver

- 0.1 to 1300 MHz continuous. (unblocked)
- NFM, WFM, AM - 700 memory channels
- Triple conversion receiver
- RF detector (Bug finder)
- Menu system
- Weighs 7 oz, 15mm thin, SMA connector

\$299^{us}

ICOM IC-R3 (unblocked)

\$569^{us} "Portable receiver with built-in TV receiver!"

- Modes of operation AM, FM, WFM, AM
- Wide frequency coverage, 0.5 to 2450 MHz.
- 450 memory ch, 6 character alphanumeric
- TV picture receive capability, NTSC, M, PAL B/G

OPTOELECTRONICS YUPITERU

Guaranteed Delivery to USA.

www.Radioworld.ca

Phone: **416-667-1000**
FAX: (416) 667-9995 sales@radioworld.ca
4335 Steeles Ave. W., Toronto, ON Canada M3N 1V7



Meet the family—the PRO base family that is. This group of receivers is probably the most popular among scanner fans from its era. And the PRO-2004 (bottom) likely holds the record for most published modifications, as it was relatively easy to work on. The PRO-2005 (middle) and 2006 (top) were follow-on receivers that improved on the overall scanner performance of the 2004. The PRO-2006 was the top-of-the-line RadioShack scanner for many years. Its popularity was probably only ended by more difficult-to-modify receivers mandated by the Electronic Communications Privacy Act. Many of you also know that there were several computer-control accessories marketed for these radios. The most popular were the Optoelectronics series (OS-456) and the CE-232 from Commtronics. These receivers can still be found in the used market and can still command quite a price.



The Standard CR708 was a favorite for some. It included a spectrum display at the left, which indicated the frequency you were tuned to and signals up to 1 MHz away. Each vertical line represents a transmitting signal, and the distance from the middle represents the distance away in frequency. With some practice, you could use this receiver to find unknown activity very rapidly.



The ICOM R3 has quite a following as well. While not exactly a common radio, it apparently has won a spot in the hearts of those who do own one, or want to. Combining the data screen, which doubles as a TV receiver, with the conventional display below, the R3 is really quite a versatile receiver in a very small package.

Ham Radio Magazine on CD-ROM

Finally, quick and easy access to back issues of Ham Radio Magazine!

These sets include high quality black and white scanned pages which are easy to read on your screen or when printed.



HOT New Item!

30,000 pages in all!

Enjoy this enormous stockpile of material including construction projects, theory, antennas, transmitters, receivers, amplifiers, HF through microwave, test equipment, accessories, FM, SSB, CW visual & digital modes. All articles, ads, columns and covers are included!

This collection is broken down into 3 sets - by year.

Each set includes 4 CD-ROMs:

1968 - 1976	Order No. HRCD1	\$59.95
1977 - 1983	Order No. HRCD2	\$59.95
1984 - 1990	Order No. HRCD 3	\$59.95

Order all 3 sets and save \$29.95!

All 3 Sets - Order No. HRCD Set \$149.95

Please add \$3 shipping & handling for 1 set; \$4 for 2 or more sets.

CQ Communications, Inc.

25 Newbridge Rd., Hicksville, NY 11801

Order Today! 1-800-853-9797

Frequency Of The Month

Our frequency this month was also suggested by a reader. Let's try 123.45, which you'll recognize as an aviation band frequency. Remember to switch to AM and see what you hear. Send your results (even if you don't hear anything) and we'll enter you into the drawing for a year's subscription to your favorite radio magazine (which I'm assuming is *Popular Communications*, of course). Mark your entries with the frequency in the subject line if e-mailed or on the envelope if sent by post so they get routed to the right place!

You can send your entry, or any questions you may have, to Ken Reiss, 9051 Watson Rd. #309, St. Louis, MO 63126 or via e-mail at radioken@earthlink.net.

Until next month, Good Listening!





GREAT New Books from CQ

Heathkit - A Guide to the Amateur Radio Products

by Chuck Penson, WA7ZZE



This greatly expanded Second Edition is a must for collectors and Ham history buffs, but is a terrific trip down memory lane for any Ham who was there or wishes he had been. Pick up this 328-page volume and you won't be able to put it down!

Order No. HEATHKIT **\$29.95**

The Short Vertical Antenna and Ground Radial

by Jerry Sevick, W2FMI



This small but solid guide walks you through the design and installation of inexpensive, yet effective short HF vertical antennas. With antenna restrictions becoming a real problem, this book could keep you on the air!

Order No. SVERT **\$10**

Understanding, Building & Using Baluns & Ununs

by Jerry Sevick, W2FMI



The successor to the popular and authoritative *Baluns and Ununs*. Great deal of new tutorial material, also includes new designs not in his previous book, and crystal clear explanations of how and why they work.

Order No. 2BU **\$19.95**

Ham Radio Magazine Anthologies

Introducing the first four of a new series of anthologies drawn from the pages of *Ham Radio* magazine. Now you can enjoy collections of the best material published in *Ham Radio* magazine, conveniently arranged by subject and by original publication date. Choose your interest, your time period, and choose your Anthology.

Homebrewing Techniques - This anthology brings together the most useful and practical advice and techniques for the person who wants to build anything from small solid state projects to beam antennas.

Order No. AHOME **\$19.95**

Test Equipment & Repair Techniques - From building test gear to trouble shooting the rig, this anthology of the best articles on the subject has been carefully selected to meet today's needs. Includes techniques and devices that work and are easily duplicated, and gives today's Hams a much-needed helping hand at solving equipment problems on their own.

Order No. ATEST **\$19.95**

Ham Radio Anthology: Antennas - Carefully selected, these first two antenna anthologies cover all types of antenna designs and theory from 160 meters through microwaves. All articles have been selected to be as timely and valuable to today's Ham as they were to *Ham Radio* readers of the time. These first two volumes will be followed by two additional volumes.

Antennas - 1968-1972.....Order No. ANT1 **\$19.95**

Antennas - 1973-1975.....Order No. ANT2 **\$19.95**

Buy all 4 Anthologies for only \$75 - Save \$\$ and get FREE Shipping & Handling!

Visit Our Web Site
www.cq-amateur-radio.com

Name _____ Callsign _____

Street Address _____

City _____ State _____ Zip _____

Qty	Item #	Description	Price	Total Price
Shipping and Handling: US and Possessions - Add \$5.00 for the first book, \$2.50 for the second, and \$1 for each additional book. FREE SHIPPING ON ORDERS OVER \$75.00 (merchandise only). Foreign - Calculated by order weight and destination and added to your credit card charge.			Shipping/Handling	
			Total	

Method of payment Check Money Order Visa MasterCard Discover American Express

Credit Card No. _____ Expiration date _____



CQ Communications Inc., 25 Newbridge Rd., Hicksville, NY 11801/516-681-2922; Fax 516-681-2926

Order Toll-Free 800-853-9797

clandestine communiqué

by Gerry L. Dexter

tuning in to anti-government radio

Togo Is New Clandestine Target, And More

Radio Togo Libre is scheduled Monday through Friday from 1300 to 14000 on **21760** and also on Sundays from 2000 to 2100 on **12125**. The site is uncertain, but may be via Meyerton, South Africa. Late information indicates that these broadcasts seem to have evolved into something of a hit and miss affair, not transmitted every day.

Another new entry is the anti-Ethiopia broadcasting effort of **Radio Fthi** (Justice), being carried by the Julich, Germany site on Sundays from 1700 to 1800 on **12120**. It's run by the Tigrayan International Solidarity for Justice and Democracy.

The Italian Radio Relay Service (IRRS) is airing **Radio Abeokuta** on Wednesdays and Fridays from 1930 to 2000 on **5780**. Some listeners in the eastern United States may have a chance at this as we edge into winter.

Although the clandestine action remains largely focused on the Middle East these days, there is interesting action a lot closer to home. The crackdown on dissidents in Cuba earlier this year, especially the execution of three men who had tried escape from Fidel's paradise, got Washington's attention. Suddenly, one of the Commando Solo EC130 propaganda planes seems to be relaying **Radio Marti**! In recent months, Marti's signal has been badly battered by Cuban jamming and it may well be that the airborne broadcasts are an attempt to get around Castro's blocking efforts. At any rate, Marti has been showing up on new channels in the 49-meter band, **6040** as well as **9295** during our evening hours. The EC-130 transmissions are on two shortwave and one mediumwave frequency (and one VHF TV Channel). How long this extra effort will continue is something probably no one knows at this point. It could already be history, but it is surely part of the new attention being paid by Washington to the Castro regime.

An Iraqi clandestine now back on the air is **Radio Bopeshawa**, operated by the Worker Communist Party of Iraq. It's on the air from 1100 to 1200 with one half-hour in Arabic and then 30 minutes of Kurdish, with the package repeating at 0500. The station announces frequencies of **5000** and **7000**, but these seem unlikely. The actual channels haven't yet been located.

Iranian clandestine **Radio Sedaye Iran** is now using **17525** (formerly 11575) for its Farsi language broadcasts from 1530 to 1730.

The anti-Zimbabwe station **SW Radio Africa** has begun broadcasting on **4880**, in addition to **6145**. The 60-meter channel seems to be active from 0400 to 0425, 0500 to 0525, and 0600 to 0625, and perhaps at other hours when they would be impossible to receive here. This seems to be some sort of testing schedule. Whether a 60-meter band frequency becomes a permanent thing or not depends on how well the tests go in comparison to reception on 6145. Anyway, if it's not too late by now, you might want to do some checks on **4880**. The address for reception reports is Technical Manager, SW Radio Africa, Ltd., P.O. Box 243, Borehamwood, Herts, WD6 4WA, United



The Movement for Islamic Reform in Arabia

Subj: Re: Reception Report

Date: 02/09/2003 12:13:49 PM Eastern Standard Time

From: saad@islah.org

To: Rdangelo3@aol.com

Sent from the Internet (Details)

thank you very much for the report

— Original Message —

From: <Rdangelo3@aol.com>

To: <info@islah.org>; <radio@islah.org>

Cc: <rdangelo@gpu.com>

Sent: Saturday, February 08, 2003 8:28 PM

Subject: Reception Report

The Movement for Islamic Reform in Arabia

Date of Birth: 11 march 1996

Current Base: London U.K

Director & Spokesman: Dr Saad Al-Fagih FRCS

For further information please email us or contact us by post or telephone.

email: info@islah.org

Address: BM Box: MIRA, London WC1N 3XX, UK.

Tel: (0208) 452 0303 Fax: (0208) 452 0808

Richard D'Angelo snared this neat but sketchy QSL from the Movement for Islamic Reform in Arabia.

Kingdom. The station appears to be transmitting from a site in South Africa.

The **Voice of Ethiopian Medhin** is now scheduled from 1800 to 1900 on **7520** and 1830 to 1930 in Amharic on **12120** Sundays only. The latter frequency is the most likely opportunity for North America.

The Sitkunai shortwave site in Lithuania is no longer relaying Iranian clandestine **Radio Barabari**.

The U.S. government's service to Iran, **Radio Farda**, is also the subject of heavy jamming by Iran. Channels such as **9510**, **9795**, **15185**, **15290**, and **17835** are all under attack by a so-called "bubble" jammer.

The **Voice of Iran** is another new anti-Tehran station, broadcasting via the Kvitsoy, Norway site. It's on the air from 1800 to 2057 on **7525** and from 1630 to 1830 on **11575** via France.

Voice of the Iraqi People, supported by the United States, is on the air from 1300 to 0300 on **9570** and **1710**. Also, 9563.1 is in use during this period and seems to be heard as well or better than 9570.

Radio Sadeye Kashmir is now on the air from 0230 to 0330 on **6100**, 0730 to 0830 on **9890**, and 1430 to 1530 on **6100**. Good luck!

The **Voice of Sudan**, operated by the National Democratic Alliance is now active from 1530 to 1630 on **8000**. Another Sudanese clandestine, the **Voice of Freedom and Renewal**, operated by the Sudan Alliance Forces, uses **6985** from 0400 sign on, except on Fridays.

The Kurdish clandestine **Denge Mesopotamia** is currently in operation from 0400 to 0800 on **11675** and from 0800 to 1600 on **11530**.

The **Voice of David**, beamed from Iran to Israel is on from 0228 opening on **9910** and runs in Hebrew until 0258.

Robert Montgomery in Pennsylvania reports reception of **Radio Sawa** on **7185** at 0235, //7205 (both Morocco) as well as **11985** and **7205** around 2330, all in Arabic. Robert Brossell of Wisconsin found them on **11785**//11985 at 0235 in AA.

Rich D'Angelo, also in Pennsylvania, heard **Radio International**, **13800** at 1650 to 1715 close, with talks in Farsi and bits of music.

That covers things for now. Your input is always welcome, whether it comes in the form of logs of the clandestine broadcasts you've received or copies of QSLs you've managed to pull in, background information on the groups that back or operate these stations, or whatever else you've got.

Thanks for your continued support and good hunting! ■

videos
videos

Super Video Sale!

- Getting Started in Ham Radio
- Getting Started in VHF
- Getting Started in DXing
- Getting Started in Packet
- Getting Started in Amateur Satellites
- Getting Started in Contesting
- Ham Radio Horizons

\$19.95 each - Now \$12.95 Buy more and save!
Buy 2 or 3 for \$11.95 each
Buy 4 to 6 for \$10.95 each
Buy all 7 for your Club for only ~~\$99.95!!~~
Now \$69.95!!

CQ Communications, Inc.
25 Newbridge Road, Hicksville, NY 11801
Fax: (516) 681-2926
Call Toll-Free: 1-800-853-9797
www.cq-amateur-radio.com

Popular Communications November Survey Questions

I replace my outdoor coax

Every year	1
Every two or three years.....	2
Every 5 years.....	3
Never	4

My Station equipment is properly grounded

Yes.....	5
No.....	6
Not Sure	7
Grounding isn't important to me.....	8

I'm a ham or CB'er and have RF problems in my shack

Yes.....	9
No.....	10
Sometimes.....	11
Only on certain frequencies	12

I operate equipment in the following type of building:

Apartment, first floor.....	13
Apartment, second floor or higher	14
My own home, basement	15
My own home, first floor	16
My own home, second floor or higher	17
Manufactured home/mobile home	18

My transmitting antenna/s are:

In the attic or crawl space.....	19
Same room as my shack	20
Outside, attached to the building.....	21
On the roof	22
In my yard, away from the building (30-feet or more).....	23
On a tower, near the building	24

My radio transmissions interfere with my neighbor's TV or home entertainment equipment

Yes.....	25
No.....	26
Not sure	27
My neighbors are more than a half-mile away.....	28
No, but I think their TV or computer monitor interferes with <i>my</i> gear	29
Don't care	30
They say so, but I'm sometimes not on the air at the times they experience interference.	31

Editor's Note: Next month we'll have a special two-page report on your responses to our surveys.

IBOC Digital Abandons PAC Codec

In-band on-channel (IBOC) digital radio developer iBiquity has announced the replacement of their proprietary PAC perceptual audio algorithm with a new codec (audio coder/decoder) to better operate within the bandwidth limitations of AM IBOC. The National Radio Standards Committee (NRSC) had temporarily suspended development of IBOC digital radio standards while iBiquity addressed audio issues with AM IBOC. In partnership with Coding Technologies, the iBiquity PAC codec has been replaced with a version of Advanced Audio Coding (AAC) customized for IBOC. The AAC Plus codec is currently used in MPEG-4, MP3 Pro, XM satellite radio, and Digital Radio Mondiale coding.

The new IBOC “HD Radio” codec, called HDC, features Coding Technologies’ Spectral Band Replication (SBR) to enable high audio quality at extremely low bit rates, one of the limiting factors of the narrow AM bandwidth. SBR is a unique bandwidth extension technique, which enables audio codecs to deliver the same quality at half the bit rate. AAC was originally designed for digital audio applications by Dolby Laboratories. Combined with Coding Technologies SBR, AAC Plus is recognized by the ISO as the world standard high-efficiency digital audio compression scheme.

Robert J. Struble, president and CEO, iBiquity Digital Corporation stated, “We’ve been working behind the scenes for quite some time on HDC and believe all of our commercialization partners will be thrilled with the audio quality of HD Radio. With the incorporation of HDC, our expectations are for a faster rollout amongst radio stations and receiver manufacturers.”

“We are proud to contribute to this project,” said Martin Dietz, president and CEO, Coding Technologies. “It was a challenging task to modify both encoder and receiver implementations in time for iBiquity’s launch, and we made it. The incorporation of SBR into the HD Radio system allowed iBiquity to achieve the level of performance needed for low bit-rate audio quality.”

“The improvement in audio quality on AM is spectacular with the HDC codec and there is improvement in FM quality as well,” said Milford Smith, chairman of the NRSC DAB Subcommittee. “Several months ago, the NRSC steering committee suspended the standard setting process for IBOC digital radio and requested that iBiquity find an effective solution to address our concerns. In my opinion, they have found that solution. Working in conjunction with my colleagues on the steering committee of the NRSC DAB subcommittee and its sponsoring organizations, we will give very serious consideration to resuming the standards setting process.”

Digital Radio Mondiale (DRM) AM digital radio broadcasts provide robust digital quality superior to local FM mono broadcasts using AAC Plus at 21 kbps. DRM broadcasts are already underway in Europe, officially inaugurated last June on the medium and short waves. Thus far, DRM broadcasts have met the challenges of long distance shortwave propagation. The switch to AAC Plus in AM IBOC should not only satisfy NRSC

The FM Pen is a unique gift for radio enthusiasts.

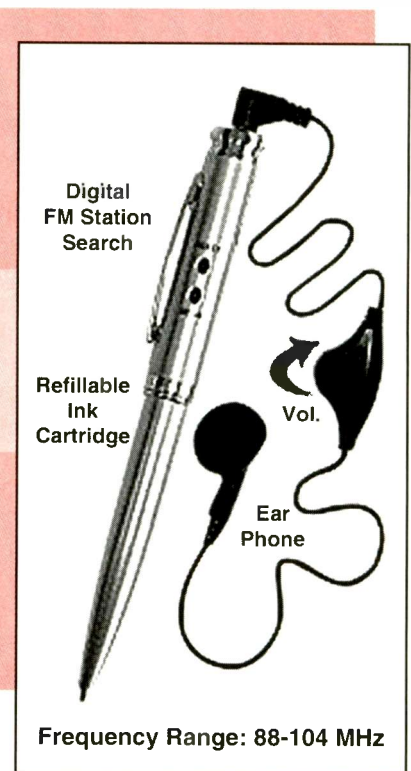

requirements, but may help push along the stalled FCC approval of nighttime AM operation, as well as the design of DRM/IBOC compatible receivers. For now though it's wait and see. Stay tuned!

AM/FM To Go

Highway Radio, A Guide to Tuning in on America's Highways is now available online. According to a press release from Bill Stank, president of AmFm2Go, “Drivers everywhere can now easily find over 12,000 AM and FM stations to listen to as they travel. Listing over 38 formats and including maps of all 50 states for orientation, www.amfm2go.com will satisfy drivers of any age anywhere. The guide includes everything from rock to talk, from news to blues. The best part is that there are no monthly fees—it's free.” AM/FM radio stations are listed by state. An online form allows users to conveniently send updates of call sign and format changes. Check it out at www.amfm2go.com.

The FM Pen

You may thank reader Richard Line for passing along the following rather intriguing item. “The FM Pen is not only a fine

RFO Guadeloupe

Réf.GUA/TEC/079/03

Baie-Mahault, le 15 Mai 2003

Monsieur,

Nous avons reçu avec plaisir votre rapport d'écoute du 18 AVR. 2003 et vous en remercions.

Nous vous précisons les horaires et les fréquences de RFO GUADELOUPE :

Nos émissions en RADIO débutent à 04h30 et se terminent à 24h00 ; suit le relais de FRANCE INTER de 24H00 à 04H30, ceci du lundi au dimanche.

Nous émettons en AM sur 640 KHz, au moyen d'un émetteur couplé 2 X 20 kilowatts avec un pylône rayonnant, et sur 1420 KHz au moyen d'un émetteur de 5 kilowatts.

Recevez, Monsieur, nos sincères salutations.

Le Responsable Technique de
RFO GUADELOUPE,

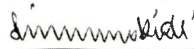
G. MOKEDE

Radio Guadeloupe verification letter received by John Fisher of Massachusetts.

writing instrument, it's also a superior quality FM radio!" opens a press release about this novelty. "If you want to discreetly listen to music while at school, at work, or in a library, this is perfect. The earphone bud actually attaches to the pen, allowing you to listen to music, while you write."

The FM Pen features adjustable volume, digital scan, and a refillable ink cartridge. Interestingly, tuning is limited to 88 to 104.5 MHz. It will not receive FM stations above 104.5 MHz. It's powered by two LR44 (AG-13) batteries. Perhaps not an engineering marvel, but it just might be the perfect gift for a fellow radio broadcast enthusiast. Visit www.youcansave.com/fmpen.asp for details.

QSL Information

540 WDMV Pocomoke City, Maryland, brief no-data verification letter and circa 1960 QSL card in 268 days, signed Choppy Layton. Address: 1637 Dun Swamp Road, Pocomoke City MD 21851. (Hochfelder, NJ)

640 RFO/R. Guadeloupe Point-a-Pitre, Guadeloupe, verification letter in 30 days, signed G. Mokeke. Mentions 40 kW on 640 and 5 kW on 1420 kHz. Address: BP 180, F-97122 Baie-Mahault, Guadeloupe. (Fisher, MA)

1570 WGSR Fernandina Beach, Florida, received a very nice full detailed QSL letter and coverage map in 54 days, signed Ron Gitschier, Technical Assist. I hear WGSR more often than any other Florida station. (Martin, OR) As of this writing, a callsign change to WNNR was pending completion of sale of the station, and antenna improvements were underway. Keep an ear to this frequency as special DX tests may be forthcoming. Thanks to Ron Gitschier.

1640 KDZR Portland, Oregon, a note on Radio Disney paper in 13 days, signed Tom White-CE. Address: 3030 SW Moody Ave, Portland OR 97201. (Martin, OR)

TV Channel 3 KTVK Phoenix, Arizona, a very friendly letter along with a really nice logo t-shirt and hat received in three weeks, signed Jim Cole, Director of Eng. Address: 5555 North 7th Avenue,

Phoenix AZ 85013. The TV stations are better QSLers than the radio stations these days! (Martin, OR)

Broadcast Loggings

It's not over until it's over, at least in terms of solar activity, as Cycle 23 refuses to quit. Mark Connelly summarizes his experience after the latest round of severe geomagnetic disturbances.

Stuff I received over in the Rowley, Massachusetts salt-marsh on the mini-Beverage bears out the auroral observations of others. Very little from northern Europe; even Spain was jumpy, but Mauritania, Morocco, Canaries, etc. nice and steady. 783 was stronger than all domestics from 700 to 800 kHz except for 720 CHTN and 730 WJTO (both groundwave). From 7:30 to 9 p.m. local time, 710 WOR was never as strong as Western Sahara on 711.05! 1088 Angola was almost as good as I've ever heard them, about equal to strength on a super reception from Orleans, Massachusetts a few years back. 1584 Ceuta was "cruncher."

A real teaser was an African music station on 945: Angola or Sao Tome? Definitely not France, since I couldn't even raise the 1206 and 1557 big guns from there. Somebody on 873 wasn't SER Spain, probably a deeper African instead. Some carrier on 1197 was probably Lesotho, but too much WKOX/YVOZ slop there. If I'd stayed out there later, I know that 1530 Sao Tome would have been a "slam dunk." The 648 Azores station (1 kW) was a real surprise, not a bad signal at times. From the south, 760 Brazil dominated that channel, 820 St. Kitts was blasting (nuking WNYC), and 1620 WDHP was about the strongest x-band station. Longwave was interesting with 189 Iceland probably pure groundwave on the 500-foot swamp-terminated wire, audible well before sundown with no apparent fading.

Skip stations that were loud were the North Africans on 153, 171, 207, and 252. The 252 station (Algeria) had a great blues program and it was so strong as to be entertainment quality. Both the aurora plus the directivity of the Beverage-on-the-ground antenna clobbered much of the would-be domestic interference. If I could only have such a set-up (Beverage + salt-marsh) for permanent use instead of having to fight off the mosquitoes while running out the wire and then retrieving it later.

Welcome to Rich Shivers, KB3FGJ, who writes,

I accepted your challenge and set off to see how many states I could hear. After four days I was able to log 16 states, Washington DC, and one Canadian province. I'm not stopping here, but I wanted to send in some initial logs, closer ones not included. I am using a Grundig YB400PE and a Lafayette HA226. The

Lafayette is more sensitive but the Grundig has the digital tuning. The antenna is a T with 40 feet above the roof and the second leg is a 15-foot vertical dropping straight down. I prefer the *North American Radio Logbook* by Lee Freshwater. www.geocities.com/amlogbook/amlog.htm, for assistance in identifying the stations.

Rich also mentions DXing with a crystal set using a five-inch basket weave coil and vintage Western Electric headphones, saying, "I've logged 30 stations

with it, including CHML Hamilton, Ontario, WHAS Louisville, Kentucky, WCGO Chicago, Illinois, WJR Detroit, Michigan, and WSAI Cincinnati, Ohio." Outstanding. Rich!

Now this month's selected logs, all times are UTC.

560 XEXZ Zacatecas, Mexico, at 2330 with full ID and into ballads. (Redding, AZ)

620 KPOJ Portland, Oregon, formerly KTLK, now an oldies rock music for-

mat, "Playing the first decade of rock 'n' roll, Super 62, KPOJ Portland," ID at 0600. (Martin, OR)

670 WWFE Miami, Florida, at 0450 weak with Spanish music. (Shivers, PA)

700 WLW Cincinnati, Ohio, at 0245 fair with talk radio. (Shivers, PA)

750 WSB Atlanta, Georgia, at 0334 strong with traffic and weather followed by the Neal Boortz Radio Show running about 10 seconds ahead of WBT. (Shivers, PA)

860 CJBC Toronto, Ontario, at 0332, a moderate signal, CBC programming in French. (Shivers, PA)

870 WWL New Orleans, Louisiana, at 0251 a religious program under heavy interference with another signal beating against this one. (Shivers, PA)

900 CHML Hamilton, Ontario, at 0400 strong with some fading, strong enough to hear on a crystal set, with Jack Benny and Abbott and Costello old-time radio shows. (Shivers, PA)

900 WSNH Nashua, New Hampshire, formerly WOTW, heard at 1000 with oldies music, "Music Power" jingle, and "The Spirit" slogan, headlining personalities formerly of Cool 96.5 WQLL FM oldies. I sense a trend toward the return of oldies music on AM radio. (Conti, NH)

1100 WTAM Cleveland, Ohio, at 0325 strong with Cleveland Indians baseball wrap-up. (Shivers, PA)

1110 WBT Charlotte, North Carolina, at 0321 strong with light fading, "The Neal Boortz Show." (Shivers, PA)

1120 KMOX St. Louis, Missouri, at 0813, moderate signal, talk radio discussion about local casinos. (Shivers, PA)

1130 CKWX Vancouver, British Columbia, at 0156 a stock report followed by the marine weather forecast. "Vancouver's All News Radio Station." Reception was poor to fair. (Griffin, OR)

1500 WTOP Washington DC at 1153 strong with local traffic and weather, then news about capture of terrorist. (Shivers, PA)

1520 WWKB Buffalo, New York, noted strong with Buffalo versus Syracuse baseball play-by-play. (Shivers, PA)

1700 WJCC Miami Springs, Florida, at 0000 noisy, fading in and out, with program in Spanish. (Shivers, PA)

Thanks to Mark Connelly, WA1ION, John Fisher, Mark Griffin, David Hochfelder, Rich Line, Patrick Martin, Kevin Redding, and Rich Shivers, KB3FGJ.

For now, 73 and Good DX! ■

REACT is growing, and

CALLING YOU!

PRESIDENT BUSH HAS ASKED CITIZENS TO TAKE PART IN VOLUNTEERISM/HOMELAND SECURITY. HERE'S YOUR CHANCE TO DO THAT WHILE ENJOYING YOUR RADIO!



REACTers provide two-way communications for safety and to coordinate local events. As a monitor you will answer calls for assistance and emergencies, the details forwarded to authorities by telephone. We use CB, GMRS, FRS, amateur, business band, and Marine VHF radios. These are also used at events such as races, parades, marathons, etc. Activities are covered by \$1,000,000 liability insurance. Equipment advice, licensing help, training, are supplied - all you need to provide service with your radio!

The REACT International mission is to provide public safety communications to individuals, organizations, and agencies to save lives, prevent injuries, and give assistance wherever and whenever needed. We strive to accomplish a monitoring network of trained volunteer citizen communicators using any and all available means to handle the message.



REACT INTERNATIONAL, INC.

Phone: (301) 316-2900

Fax: (301) 316-2903

(866) REACT99 (Membership Inquiry)

Web: www.reactintl.org

5210 Auth Road, Suite 403

Suitland, MD 20746

* PROUD RECIPIENT OF THE PRESIDENT'S VOLUNTEER ACTION AWARD *

RADIO EMERGENCY ASSOCIATED COMMUNICATIONS TEAMS



Tap into secret Shortwave Signals

Turn mysterious signals into exciting text messages with the MFJ MultiReader™!

Plug this self-contained MFJ MultiReader™ into your shortwave receiver's earphone jack.

Then watch mysterious chirps, whistles and buzzing sounds of RTTY, ASCII, CW and AMTOR (FEC) turn into exciting text messages as they scroll across an easy-to-read LCD display.

You'll read interesting commercial, military, diplomatic, weather, aeronautical, maritime and amateur traffic . . .

Eavesdrop on the World

Eavesdrop on the world's press agencies transmitting *unedited* late breaking news in English -- China News in Taiwan, Tanjug Press in Serbia, Iraqi News in Iraq -- all on RTTY.

Copy RTTY weather stations from Antarctica, Mali, Congo and many others. Listen to military RTTY passing traffic from Panama, Cyprus, Peru, Capetown, London and others. Listen to hams, diplomatic, research, commercial and maritime RTTY.

Listen to maritime users, diplomats and amateurs send and receive *error-free* messages using various forms of TOR (Telex-Over-Radio).

Monitor Morse code from hams, military, commercial, aeronautical, diplomatic, maritime

Super Active Antenna

"World Radio TV Handbook" says MFJ-1024 is a "first-rate easy-to-operate active antenna...quiet... excellent dynamic range... good gain... low noise... broad frequency coverage."

Mount it outdoors away from electrical noise for maximum signal, minimum noise. Covers 50 KHz-30 MHz.

Receives strong, clear signals from all over the world. 20 dB attenuator, gain control, ON LED.

Switch two receivers and auxiliary or active antenna. MFJ-1024 has 54 inch whip, 50 feet coax. 3x2x4 inches. 12 VDC or 110 VAC with MFJ-1312, \$14.95.

Receives strong, clear signals from all over the world. 20 dB attenuator, gain control, ON LED.

Indoor Active Antenna

Rival outside long wires with this tuned indoor active antenna.

"World Radio TV Handbook" says MFJ-1020B is a "fine value... fair price... best offering to date... performs very well indeed."

Tuned circuitry minimizes intermod, improves selectivity, reduces noise outside tuned band. Use as a preselector with external antenna. Covers 0.3-30 MHz. Tune, Band, Gain, On/Off/Bypass Controls. Detachable telescoping whip. 5x2x6 in. Use 9 volt battery, 9-18 VDC or 110 VAC with MFJ-1312, \$14.95.

Compact Active Antenna

Plug this compact MFJ all band active antenna into your receiver and you'll hear strong, clear signals from all over the world. 300 KHz-200 MHz including low, medium, shortwave and VHF bands.

Detachable 20 inch telescoping antenna. 9 volt battery or 110 VAC MFJ-1312B, \$14.95. 3/4x1 1/4x4 in.

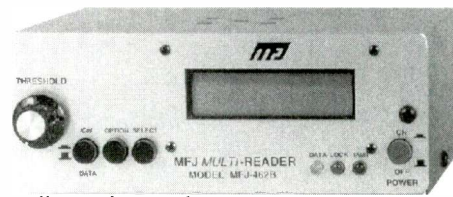

-- all over the world -- Australia, Russia, Japan, etc. MFJ-462B
Printer Monitors \$179⁹⁵
24 Hours a Day

MFJ's exclusive TelePrinterPort™ lets you monitor any station 24 hours a day by printing transmissions on an Epson compatible printer. Printer cable, MFJ-5412, \$9.95.

MFJ MessageSaver™ You can save several pages of text in an 8K of memory for re-reading or later review.

High Performance Modem MFJ's high performance PhaseLockLoop™ modem consistently gives you solid copy -- even with weak signals buried in noise. New threshold control minimizes noise interference --

greatly improves copy on CW and other modes.

Easy to use, tune and read

It's easy to use -- just push a button to select modes and features from a menu.

It's easy to tune -- a precision tuning indicator makes tuning your receiver easy for best copy.

It's easy to read -- the 2 line 16 character LCD display with contrast adjustment is mounted on a brushed aluminum front panel for easy reading.

Copies most standard shifts and speeds. Has MFJ AutoTrak™ Morse code speed tracking.

Use 12 VDC or use 110 VAC with MFJ-1312B AC adapter, \$14.95. 5 1/2"Wx2 1/2"Hx5 1/4"D inches.

No Matter What™ One Year Warranty

You get MFJ's famous one year No Matter What™ limited warranty. That means we will repair or replace your MFJ MultiReader™ (at our option) no matter what for one full year.

Try it for 30 Days

If you're not completely satisfied, simply return it within 30 days for a prompt and courteous refund (less shipping). Customer must retain dated proof-of-purchase direct from MFJ.

Eliminate power line noise!



New! Completely eliminate power line noise, lightning crashes and interference before they get into your receiver! Works on all modes -- SSB, AM, CW, FM, data -- and on all shortwave bands. Plugs between main external antenna and receiver. Built-in active antenna picks up power line noise and cancels undesirable noise from main antenna. Also makes excellent active antenna.



Matches your antenna to your receiver so you get maximum signal and minimum loss.

Preamp with gain control boosts weak stations 10 times. 20 dB attenuator prevents overload. Select 2 antennas and 2 receivers. 1.6-30 MHz. 9x2x6 in. Use 9-18 VDC or 110 VAC with MFJ-1312, \$14.95.



Two separately tunable filters let you peak desired signals and notch out interference at the same time. You can peak, notch, low or high pass signals to eliminate heterodynes and interference. Plugs between radio and speaker or phones. 10x2x6 in.



High-gain, high-Q receiver preselector covers 1.8-54 MHz. Boost weak signals 10 times with low noise dual gate MOSFET. Reject out-of-band signals and images with high-Q tuned circuits. Push buttons let you select 2 antennas and 2 receivers. Dual coax and phono connectors. Use 9-18 VDC or 110 VAC with MFJ-1312, \$14.95.

CW, RTTY, ASCII Interface

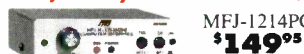

Use your computer and radio to receive and display brilliant full color FAX news photos and incredible WeFAX weather maps. Also RTTY, ASCII and Morse code. Frequency manager lists over 900 FAX stations. Auto picture saver.

Includes interface, easy-to-use menu driven software, cables, power supply, manual and JumpStart™ guide. Requires 286 or better computer with VGA monitor.

High-Q Passive Preselector



High-Q passive LC preselector boosts your favorite stations while rejecting images, intermod and phantom signals. 1.5-30 MHz. Preselector bypass and receiver grounded positions. Tiny 2x3x4 inches.

Super Passive Preselector



New! Improves any receiver! Suppresses strong out-of-band signals that cause intermod, blocking, cross modulation and phantom signals. Unique Hi-Q series tuned circuit adds super sharp front-end selectivity with excellent stopband attenuation and very low passband loss. Air variable capacitor with vernier. 1.6-33 MHz.

Easy-Up Antennas

How to build and put up inexpensive, fully tested wire antennas using readily available parts that'll bring signals in like you've never heard before. Antennas from 100 KHz to 1000 MHz.

MFJ Antenna Switches



MFJ-1704 heavy duty antenna switch lets you select 4 antennas or ground them for static and lightning protection. Unused antennas automatically grounded. Replaceable lightning surge protection. Good to 500 MHz. 60 dB isolation at 30 MHz. MFJ-1702C for 2 antennas.

World Band Radio Kit

Build this regenerative shortwave receiver kit and listen to signals from all over the world with just a 10 foot wire antenna. Has RF stage, vernier reduction drive, smooth regeneration, five bands.

21 Band World Receiver

MFJ's new 21 Band World Receiver lets you travel the world from your armchair! Listen to BBC news from London, live music from Paris, soccer matches from Germany and more! Covers 21 bands including FM, Medium Wave, Long Wave and Shortwave. Sony® integrated circuit from Japan, multicolored tuning dial, built-in telescopic antenna, permanent silkscreened world time zone, frequency charts on back panel. Carrying handle. Operates on four "AA"s. Super compact size!

Free MFJ Catalog and Nearest Dealer . . . 800-647-1800

http://www.mjenterprises.com
• 1 Year No Matter What™ warranty • 30 day money back guarantee (less s/h) on orders from MFJ

MFJ ENTERPRISES, INC.
Box 494, Miss. State, MS 39762
(662) 323-5869; 8:4-3:30 CST, Mon.-Fri.
FAX: (662) 323-6551; Add s/h
Tech Help: (662) 323-0549

Prices and specifications subject to change. (c) 1998 MFJ Enterprises, Inc.

world band

tuning tips *your monthly international radio map*

This listing is designed to help you hear more shortwave broadcasting stations. The list includes a variety of stations, including international broadcasters beaming programs to North America, others to other parts of the world, as well as local and regional shortwave stations. Many of the transmissions listed here are not in English. Your ability to receive these stations will depend on time of day, time of year, your geographic location, highly variable propagation conditions, and the receiving equipment used.

AA, FF, SS, GG, etc. are abbreviations for languages (Arabic, French, Spanish, German). Times given are in UTC, which is five hours ahead of EST, i.e. 0000 UTC equals 7 p.m. EST, 6 p.m. CST, 4 p.m. PST.

UTC	Freq.	Station/Country	Notes	UTC	Freq.	Station/Country	Notes
0000	15760	Kol Israel		0230	11700	Radio Bulgaria	
0000	6797.5	Ondas del Rio Mayo, Peru	SS	0230	7160	Radio Tirana, Albania	
0030	11950	UAE Radio	AA	0300	4976	Radio Uganda	
0030	6536	Radiodifusora Huancabamba, Peru	SS	0300	15475	Sri Lanka Broadcasting Corp.	
0030	4845	Radio Mauritanie, Mauritania	AA	0300	3320	Radio Sondergrense, South Africa	Afrikaans
0030	4717	Radio Yura, Bolivia	SS	0300	11750	Voice of Russia	
0030	9465	Far East Broadcasting Assn, via Austria		0300	12040	Radio Ukraine Int'l	
0030	4052	Radio Verdad, Guatemala	SS	0300	15395	Radio Thailand	
0030	5678	Radio Ilucan, Peru	SS	0300	15575	BBC Relay, Oman	
0100	7120	VOA Relay, Sri Lanka		0300	5010	RTV Malagasy, Madagascar	vern
0100	7507	Armed Forces Network, via Puerto Rico		0300	4800	Radio Lesotho	vern
0100	9845	Radio Netherlands Relay, Bonaire, NWI		0300	9475	Radio Cairo, Egypt	
0100	11760	Radio Havana Cuba	SS	0300	9870	Radio Prague, Czech Republic	
0100	11780	Radio Nacional Amazonas, Brazil	PP	0300	9925	Voice of Croatia, via Germany	SS/EE
0100	5446.5	Armed Forces Network, Florida	usb	0300	4820	Radio Botswana	vern
0100	7265	Info Radio, Germany	GG	0300	15565	Radio Vlaanderen Int'l, Belgium, via Bonaire	
0100	9590	Radio Budapest, Hungary		0300	11725	Radio Liberty, USA, via Morocco	RR
0100	6215	Radio Baluarte, Argentina	SS/PP	0330	15420	BBC Relay, Seychelles	
0130	11885	Voice of Turkey	TT	0330	13675	UAE Radio	
0130	15150	VOA Relay, Thailand	CC	0330	15560	Radio Netherlands Relay, Madagascar	DD
0130	11725	Voice of Russia		0330	4819	La Voz Evangelica, Honduras	SS
0130	4800	Radio Buenas Nuevas, Guatemala	SS	0330	4950	Radio Nacional, Angola	PP
0130	11920	HCJB, Ecuador	SS	0330	6175	Voice of Vietnam, via Canada	
0130	6585.5	Radio Nueva Esperanza, Bolivia	SS	0400	12005	RTT Tunisienne, Tunisia	AA
0130	6040	Radio Clube Paranaense, Brazil	PP	0400	7120	BBC, via South Africa	
0130	4985	Radio Brazil Central, Brazil	PP	0400	4910	Radio Zambia	
0145	6115	Radio Tirana, Albania		0400	11920	RTV Marocaine, Morocco	AA
0200	9560	Radio Korea Int'l, South Korea		0400	10320	Armed Forces Network, Hawaii	usb
0200	15120	Radio Pilipinas, Philippines		0400	15630	Voice of Greece	VGreek
0200	17675	Radio New Zealand Int'l		0400	4915	Radio Nacional Macapa, Brazil	PP
0200	5010	Radio Misiones Int'l/HRMI, Honduras	SS	0400	4890	Radio France International, via Gabon	FF
0200	3300	Radio Cultural, Guatemala	SS	0400	4960	VOA Relay, Sao Tome	
0200	9400	Radio Bulgaria		0430	3326	Radio Nigeria	
0200	9645	Radio Bandeirantes, Brazil	PP	0430	12060	Radio Voice of Hope, Madagascar	
0200	11710	RAE, Argentina		0430	9475	Radio Denmark, via Norway	DD
0200	7210	Radio Belarus		0430	9635	Radio Nacional, Colombia	SS
0230	11940	Radio Romania Int'l	FF	0430	9875	RAI Int'l, Italy	II
0230	9770	Radio Mexico Int'l	SS	0500	11710	Channel Africa, South Africa	
0230	15495	Radio Kuwait	AA	0500	11625	Vatican Radio	
0230	11610	Voice of Islamic Republic of Iran	unid	0500	7255	Voice of Nigeria	
0230	15135	All India Radio	Hindi	0500	11970	Voice of Germany	GG
0230	7477	Voice of Greece	Greek				

UTC	Freq.	Station/Country	Notes	UTC	Freq.	Station/Country	Notes
0500	5985	Radio Congo	vern/FF	1330	17775	Radio Tashkent, Uzbekistan	
0500	5025	Radio Rebelde, Cuba	SS	1330	9835	Far East Broadcasting Co., Philippines	CC
0600	15345	Adventist World Radio, via South Africa		1400	9540	Radio Veritas Asia, Philippines	unid
0600	4915	Radio Ghana		1400	11770	Radio Mexico Int'l	SS
0600	11710	Radio France International		1430	21760	Channel Africa, South Africa	
0600	4780	ORTB, Benin	FF	1430	9620	All India Radio	unid
0600	5047	Radio Togo	FF	1500	11765	Radio Free Asia, USA, via Northern Marianas	CC
0630	6020	Radio Victoria, Peru	SS	1500	11705	Radio Japan/NHK	
0700	15675	Voice of Mesopotamia, via Uzbekistan		1500	15330	KTWR/Trans World Radio, Guam	
0700	6185	Radio Educacion, Mexico	SS	1530	17735	RTT Tunisienne, Tunisia	AA
0700	5470	Radio Veritas, Liberia		1530	17630	Adventist World Radio, via UAE	unid
0700	9870	Trans World Radio, Monte Carlo		1530	15345	RTV Marocaine, Morocco	AA
0800	6070	CFRX, Canada relay CFRB		1530	9635	Voice of Islamic Republic of Iran	
0800	11765	KNLS, Alaska		1530	21630	Radio Japan/NHK, via Ascension Is.	JJ
0830	3290	Voice of Guyana		1530	17715	Voice of Germany	GG
0830	6010	La Voz de su Conciencia, Colombia	SS	1550	11500	Voice of Russia via Tajikistan	
0900	5580	Radio San Jose, Bolivia	SS	1600	15065	Radio Pakistan	
0900	11775	Caribbean Beacon/University Network, Anguilla		1630	15475	Africa Number One, Gabon	FF
0900	4620	Nei Menggu PBS, China	CC	1730	15715	Radio Africa Int'l, via Germany	
0930	4890	NBC, Papua New Guinea		1800	15585	RTE, Ireland, via UK	
1000	5020	Solomon Islands Broadcasting Corporation		1800	15450	BBC, England	Somali
1000	5487	Reina de la Selva, Peru	SS	1800	11890	Radio Jamahiriya, Libya, via France	AA
1000	12085	Voice of Mongolia		1830	13580	Radio Prague, Czech Republic	FF
1000	6035	La Voz del Guaviare, Colombia	SS	1900	17575	RDP Int'l, Portugal	PP
1030	12020	Voice of Vietnam		1900	17505	Norwegian Radio	NN
1030	9885	Radio New Zealand Int'l		1930	15220	Swiss Radio Int'l	
1030	5010	Radio Cristal, Dominican Republic	SS	1930	15310	Radio Jamahiriya, Libya	AA
1030	9695	Radio Rio Mar, Brazil	PP	1930	17535	Kol Israel	HH
1030	9675	Radio Cancao Nova, Brazil	PP	1930	17660	Adventist World Radio, via UK	
1100	3235	Radio West New Britain, Papua New Guinea	Pidgin	1930	21500	Voz Cristiana, Chile	SS
1100	21645	Radio France Int'l	SS	2000	12060	Voice of the Mediterranean, via Russia	
1100	4870	Radio Republik Indonesia - Wamena	II	2000	15120	Voice of Nigeria	
1100	9600	Radio Rebelde, Cuba	SS	2000	12050	Radio Cairo, Egypt	AA
1130	9900	Deutsche Welle, via Russia	GG	2000	17870	Radio Canada Int'l	
1130	3315	Radio Manus, Papua New Guinea	Pidgin	2030	15150	Voice of Indonesia	unid
1130	4790	Radio Atlantida, Peru	SS	2030	11735	Radio Tanzania - Zanzibar	Swahili
1130	7580	Voice of Korea, North Korea	KK	2100	13610	Radio Damascus, Syria	
1130	11580	KFBS, Northern Marianas	CC	2100	9870	Broadcasting Svc of Kingdom of Saudi Arabia	AA
1130	9930	KWHR, Hawaii		2100	15600	Radio Taiwan Int'l, via WYFR	
1130	11560	Adventist World Radio, Guam	CC	2100	17630	Radio France Int'l	SS
1130	6050	HCJB, Ecuador		2100	9410	BBC Relay, Cyprus	
1130	11590	Haixa Zhi Sheng (V. of Strait), China	CC	2100	15445	VOA Relay, Botswana	
1200	9765	Radio Exterior de Espana, Spain	SS	2100	21740	Radio Australia	
1200	11945	BBC Relay, Singapore		2130	17860	Deutsche Welle Relay, Rwanda	
1200	12075	Radio France Int'l, via Russia	CC	2130	11905	Radio Tashkent, Uzbekistan	
1200	15735	Norwegian Radio	NN	2130	17740	VOA Relay, Philippines	
1200	15400	YLE/Radio Finland	Finnish	2130	17825	Radio Japan/NHK	
1200	11935	Voz Cristiana, Chile	SS	2130	15445	VOA Relay, Morocco	
1200	9865	Radio Vlaanderen Int'l, Belgium, via Russia		2130	11810	Radio Jordan	AA
1200	13730	Radio Austria Int'l	GG	2130	9990	Radio Cairo, Egypt	
1200	11650	Radio Australia		2200	12000	Voice of Turkey	
1300	15265	Radio Taiwan Int'l	CC	2200	11800	RAI Int'l, Italy	
1300	6150	Radio Singapore		2200	11620	All India Radio	
1300	21810	RDP Int'l, Portugal	PP	2230	13855	Armed Forces Network, Iceland	usb
1300	11710	Voice of Korea		2230	17880	Radio Canada Int'l	SS
1300	6309	Armed Forces Network, Hawaii	usb	2230	11600	Radio Prague, Czech Republic	
1330	17580	Radio Netherlands, via Madagascar	DD	2300	9875	Radio Vilnius, Lithuania	
1330	7295	Radio Malaysia		2330	13650	China Radio Int'l, via Cuba	

radios & high-tech gear

review of new, interesting, and useful communications products

Lightning Bond And Dr. Mike's Model-'n Crafter's Glue

We've highlighted Lightning Bond here before, and got so many calls and letters that we decided it was time to check 'em out again. These two adhesives have extremely long shelf lives after they are opened. They meet all modeler's needs as they bond everything, including brass, pewter (white metal), delrin, styrene, wood, rubber, polys, leather, glass, resins, and other products that store and carry petroleum commodities.

Lightning Bond is a new high-tech adhesive that works almost like anaerobics, which means it works on lack of oxygen to bond. It has a three-year shelf life if taken care of. It's packaged with a bottle of filler, which is used to reinforce joints and for repairs to replace a missing part, to fill in a hole, etc. This fantastic product is machineable within minutes.

Dr. Mike's Model-'n Crafter's Glue has many applications in the shack and around the home. It can be used to bond plastic and other products. It's perfect for railroad modelers as it can bond Grandt delrin couplers and handrails to styrene, along with woods like pine, mahogany, and many others used for modeling, crafting, and antique repairs. I've used it extensively with the filler to glue a small coax balun to a Cubex quad antenna, repaired an outdoor ground-level lamp, and an old classic transistor radio knob.

Lightning Bond's shelf life after opening is three years with storage temperatures of 65 degrees F or less, and Dr. Mike's has an eight-plus month shelf life after opening kept at or near the same temperature.

Refrigeration to extend shelf life is fine for either, but not necessary if just kept cool and out of sun, like all adhesives. You can leave either glue open all day long and neither will dry out.

Mike Rice, President of Innovative Promotions, LLC, markets these adhesives via mail and at some major train shows and other types of events (including some hamfests!). His website at DrMikesGlue.com makes it easier for you to purchase anytime. He's also been marketing Lightning Bond, which retails for \$15 for a 10-gram bottle kit with filler and \$20 for a 20-gram kit. Dr. Mike's retails for \$11.95 for a 14.2-gram (half-ounce) bottle. While they may seem pricey, when you consider that



Dr. Mike's Model-'n Crafter's glue is a must-have in your radio shack and around the home.

most folks buy a \$5 bottle of regular super-type CA adhesive every couple of months, these adhesives last for eight months to three years and are, therefore, quite reasonable. The accelerator is \$6.95 for two fluid ounces.

If you have any questions contact Mike at DrMikesGlue@aol.com or visit their website. Please tell him you read about it in *Popular Communications*.

PowerPort Radio GearHarness

Recently I had the opportunity to accompany an associate on an archeological survey of Indian sites in remote areas of Utah. As I was considering what to pack and how to carry all of the gear I needed, a buddy of mine recommended a PowerPort Radio GearHarness. What a life-saver! This bandolier-style harness is lightweight, has a variety of pockets, and is extremely useful for many purposes. Other harnesses I've tried in the past were cut poorly and were not comfortable over time. They would rub against my arm, or were just too dense and heavy, causing me to sweat and chafe.

The PowerPort GearHarness is made of a medium weight, lightly padded nylon with a mesh backing that allows air to circulate easily between your body and the harness. There are three main pockets: two designed for handheld-sized radios and one larger horizontal pocket with a Velcro rain flap that was great for carrying my digital camera. Although the back shoulder-blade pocket was intended for a second handheld radio (who really needs *two* HTs?), I found it to be a perfect place for my handheld GPS. It allowed for great sky view and, therefore, strong GPS signal. When I carry the GPS on my belt, it drops the signal quite regularly and doesn't give me an accurate trail at the end of the day. Using the shoulder-blade pocket worked much better. The same advantages applied to my 2-meter amateur handheld carried in the front pocket.

Two narrow vertical pockets are perfect for a pen and a spare antenna, and a glow stick for night work. The GearHarness also has a map pocket that runs the width of the front of the harness with a discreet zipper along the top edge—a great place



PowerPort's GearHarness holds a couple of your HTs and small accessories securely, and ready for immediate access.

to stash my notepad and topo maps for quick reference. All of these features, along with many attachment points, make this a great way to have quick and easy access to all of my basic necessities while on the move.

One of our companions was a Ski Patrol Search and Rescue professional. He was eyeballing my GearHarness covetously, noting the many ways that it was superior to the standard issue one that he was using this past winter. The GearHarness is now part of my basic kit for any kind of travel, hiking, field days, and public service work.

You can purchase a GearHarness for \$36.95 through Cutting Edge Enterprises' website at www.powerportstore.com or by calling 800-206-0115.

SkySweeper PRO: For The Professional Monitor

SkySweeper PRO is the newest member of the SkySweeper product family. This new, professional version is targeted toward government agencies, professional radio monitoring, and the advanced ham or utilities DXer. But the PRO version is still simple enough that a hobbyist looking for a more advanced decoder will be pleased with its ease of use and state-of-the-art advanced features.

SkySweeper PRO offers all the features of SkySweeper standard and, in addition, contains very advanced signal analyzers and decoding tools. There are analyzers for signal and modulation analysis, such as high-resolution FFT, modulation speed, and signal phase analyzers, as well as bit domain analyzers. Plus there are several generic (universal) decoders (FSK, MFSK, MPSK, MSK, PAM, and PSK), which are used to decode known and unknown transmissions. The generic decoders combined with universal bit tools provide the very best tools in the market for digital transmission decoding and analysis. These "generic" analyzers can be configured to almost any type of transmission mode. The more advanced the user, the more advanced the tools can become.

In the near future there will be even more new decoders added to the Professional version, such as DTMF, COQUELET, PIC-COLO, STANAG 4825, and Mil-STD-110. These additions will be a no-charge upgrade for registered Professional owners.

Computer-Aided Technologies invites you to take a "test drive" of the SkySweeper PRO. U.S. residents can download the SkySweep demo from their website at <http://www.scancat.com/download.com>. European residents can download the demo from SkySweeper's site at http://www.skysweep.com/download_frame_pro.htm. If you already own SkySweeper "Standard" an upgrade price is available. Contact Computer-Aided Technologies for details and pricing. They're the U.S. dealer for SkySweeper and SkySweeper PRO, and they accept VISA/MasterCard and AMEX. For a limited time, included with your purchase will be a CD that contains their "Disk Full of Frequencies," a \$15 value at no charge. You can purchase and register online using the company's Shopping Cart.

For more information, contact Computer-Aided Technologies, P.O. Box 18285, Shreveport, LA 71118 or order toll-free at 888-722-6228. You can also e-mail questions to them at scancat@scancat.com. Be sure to tell them you read about SkySweeper PRO in *Pop'Comm*.

ORDER ONLINE WWW.SCANCAT.COM

SCANCAT® GOLD for Windows

Since 1989, The Recognized Leader
in Computer Control

ORDER
ONLINE
AND RECEIVE
GROVE HOT 1000
HF
FREQUENCIES
FREE!

TRUNKING
SUPPORT FOR
BC250, BC785,
BC780, BC895,
BC245,
Pro2052



Once you use SCANCAT with YOUR radio, you'll
NEVER use your radio again WITHOUT SCANCAT!

SCANCAT supports almost ALL computer controlled radios by: AOR, DRAKE, KENWOOD, ICOM, YAESU, JRC (NRD) and Ten-Tec Plus PRO-2005/6/35/42 (with OS456/535), Lowe HF-150, and Watkins-Johnson

Announcing Scancat-Gold for Windows Version 8.2552

Supports all radios in ONE program - share files with all radios.

- Two Scanning modules:
 - A Simple Basic Module - for beginners
 - Plus**—An Advanced Scanning System for the "experts".
- New "Folder Tabbed" GUI puts everything at your fingertips
- Faster scanning speeds
- Extensive on screen help
- Completely revised printed manual- Over 160 pgs.
- Trunking support for BC780, BC895, BC245, Pro2052, BC250 and BC785
- EXPANDED import from EXCEL and NAT-COM frequency files.

Scancat-Gold for Windows-SE - improved Features for
Ver 8.2552 All the features of our "Standard Scancat" plus
these additional functions:

- Long term logging of frequencies to hard drive.
- Record Audio to hard drive using sound card.
- NEW report generator with user defined printouts.
- NEW - Records audio when "Trunktracking" or conventional scanning.
- Improved spectrum analysis with several great graphical analysis screens.

STILL THE SAME GREAT PRICE!

Scancat-Gold for Windows\$99.95
Scancat-Gold for Windows-SE\$159.95
Upgrades: Scancat-Gold for Windows.....\$29.95 + S&H
Upgrades: Scancat-Gold for Windows-SE\$59.95 S&H*

*\$79.95 AFTER 1 YEAR OF PURCHASE

S&H \$5 U.S. \$7.50 FOREIGN

MAGIC for Windows

PUT SOME
ORDER IN
YOUR LIFE!

If You're Not Using MAGIC,
You're Only Enjoying
Half The Hobby.



Super File Conversion Utility—
Reads & Writes to over
10 database formats.

- Creates databases from plain
ASCII text.

• Converts most popular file formats

OUR MOST POPULAR PACKAGE

Limited Time Thru 11/30/2003

Scancat Gold for Windows\$99.95
Magic for Windows.....34.95
Disk of Frequency Files15.00

Regular Price\$149.85

SPECIAL\$124.95

For "SE" Add\$59.95

"SPECIAL SCGM"

Skysweep Decoder Software



Order
On Line
\$99.95

Advanced Digital Signal
Processing Software For
HF/VHF Applications

All you need is any
Windows® soundcard
demo on our website

FREE FREQ FILES from our
WEBSITE - www.scancat.com
E-MAIL - info@scancat.com

FREE DEMOS

COMPUTER AIDED TECHNOLOGIES

P.O. Box 18285 Shreveport, LA 71138

ORDERS: (318) 687-4444 FAX: (318) 686-0449

Info/Tech Support: (318) 687-2555 (9 a.m. - 3 p.m. Central M-F)





Shannon's Broadcast Classics

a look back at radio & TV's golden years

Music Under The AM Band

It fell slowly like one of those helicopter seedpods spiraling from a lush tree in the wind. I'd been looking through a shoebox filled with old QSLs, station music surveys, and a few bumper stickers when the colorful British countryside greeting card tumbled gracefully from the bunch.

Nearly a decade ago, my old freshman college roommate—who shortly after graduation married a guy from a family with several radio stations—had sent me the card inscribed with a description of their adventures in England's Lake District. I must have filed it with the QSLs because the card also included a brief expose' about a fascinating Ireland-based longwave radio outlet that her husband later penned for their state broadcasting association's newsletter. So we'll get the context correct, her name is Eileen. Hubby, Jack, gave me permission to reprint his article, though it's in his first person, so don't get confused...

Low Frequency, High Power, and Lots of Listeners

by Jack Sparrow

A proper English proprietress lead my wife, Eileen, and me up three, "head-ducked," winding flights of Bed & Breakfast's stairs. The journey's pinnacle was a little room boasting a breathtaking view of village and countryside.

"I trust everything will be to your satisfaction," our hostess bowed. "Extra pillows, comforter, a teapot, tele, and clock radio."

"This is all very romantic," Eileen smiled, checking out a small box of English "biscuits," or cookies, and the selection of teas.

"Hey, look...this radio gets Long Wave," I noticed.

"Oh no," my wife sighed, "we didn't come all this way just to tune a dial."

"But, do you realize how rare it is to see a clock radio with MW, VHF, and LW?!"

With classic Churchillian diplomacy, the B&B owner recalled Eileen's plans to do some shopping in the morning, and suggested I save the radio until then. "No doubt, sir," she indicated, "Atlantic 252 will still be ready and waiting for you tomorrow."

And it was. Except for some very erudite and distant-sounding BBC transmissions, a station dubbed Atlantic 252 had that little clock radio's (160-260 kHz.) Long Wave band all to itself. From the tiny speaker flew hits by contemporary groups like R-



E-M, U-2, and UB-40. There was a lot of music, occasionally bridged with an American-voiced liner touting "LONG WAVE, Atlantic 252." Anyone who remembers the big deal pioneer FM rockers made out of the phrase, "F-M STER-E-O," would recognize that sort of pride in Atlantic 252's Long Wave claim. Perhaps some listeners were impressed with the thought that long waves were much better than medium, or short ones?

Throughout the morning, Atlantic 252's signal filled the room with tons of tunes, and a minimum of talk from those recorded "liners," as well as via a live air-personality. Researched stop-sets containing national advertising paid the way. Contests were brief, but their excited phone-in participants supported the format and tempo. Weathercasts were directed to all of England, concluding with a single present temperature "at Atlantic 252." Whether blasting into that cozy attic room or fading in and out with long breaths characteristic of low frequency transmission, the signal consistently exhibited a mysterious smooth-sounding quality that made me feel I'd dialed in a real catch.

Nighttime reception—admittedly, I was at least 200 miles from the LW outlet's transmitter—was a bit challenging and, with the teapot heating element activated, subject to bursts of electrical interference. An evening thunderstorm really caused a radio signal ruckus, which was just as well because Eileen wasn't planning that we DX after dark at a B&B. Even so, regularly catching something that distant on an inexpensive receiver (comparable to an \$8.88 AM/FM chain store special sold in bubble packaging) is noteworthy.

What makes such a "more-music/less talk" facility particularly interesting, however, is that it's reaching a sizable young audience well under the AM broadcast band—a slice of spectrum long abandoned by most American music radio pundits.

In order to learn whether or not the chaps at Atlantic 252 know something we don't, I picked up a copy Paul Donovan's

2-23-67 8:00 PM EST

You Heard Us!
 and this is your Verification

TRANSMITTER LOCATED IN
MONTGOMERY COUNTY, PA.

ANTENNA
Five 250 ft. Towers
 DIRECTIONAL



WIBG

990 kc. 10,000 Watts
 1423-25 WALNUT STREET
 PHILADELPHIA 2, PA.

Thanks for Listening



CHIEF ENGINEER

SEABOARD RADIO BROADCASTING CORP.

A 1967 QSL from WIBG.

The [British] Radio Companion (Grafton Books), and then stopped by the station's London sales office.

Throughout much of the Beatle-era, residents of the United Kingdom were "officially" limited from hearing their favourite records on the radio. In fact, the British Broadcasting Corporation outlets often spun cover versions of contemporary fare or had studio orchestras/singers imitate the tunes well into the 1960s. Much to the BBC's chagrin, Radio Luxembourg (on 1440 kHz) nighttime skywave and sea faring "pirate" stations gave young music lovers tastes of commercialized Top-40.

When most of the major renegade facilities (such as Radio London, anchored several miles off the English coast) were silenced in 1967, a "legal" but non-commercial pop music replacement, BBC Radio 1, went on the air. Eventually, some listener surveys showed Radio 1's disk jockeys or "presenters" were getting "excessively chatty." By the late eighties, officials at Radio Luxembourg teamed with an Irish firm to carry out a plan to fill a perceived programming niche.

The resulting organization built an 800-foot tower about 25 miles outside of Dublin, then connected it to Continental brand transmitters capable of half-a-million watts at 252 kilohertz. When their Atlantic 252 took to the air in the fall of 1989, it was U.K.'s only commercial radio service with enough punch to cover the nation. Reportedly, the big Texas-built, Continental brand transmission system cost some \$1,500 per day to power. Cooling was facilitated with a complex network of pipes, liquid, and blowers (some turned by 10-horsepower electric motors). Studios were hidden away in an

historic former private home (known as Mornington House) in the quaint Irish village of Trim. A small studio was also set up in London.

Ratings in England's Midlands, North, as well as in Scotland and Wales materialized quickly. Atlantic 252 account executives offered advertisers a weekly come of over a million youthful (15-34) listeners. In 1991, the daily broadcast schedule pulled-in even greater numbers when upped to a full 24 hours of hit music programming.

Of course, when developing an audience, prizes help. Atlantic 252 owners knew the station's Irish base was not within British regulatory reach. Consequently, they could design as large of a giveaway as needed to attract the attention of potential listeners. So, many thousands of pounds were awarded that local, commercial British stations—then beginning to be authorized predominantly with several hundred watts of FM—felt unfairly bound. Perhaps especially during its initial phase, Atlantic 252 might have reminded UK radio buffs of an offshore "pirate" station, out to rake in the audience.

During 252's air studio design phase, American-born DJ, Charlie Wolf, influenced engineers to position the control board furniture top three feet off the floor. That done, Wolf and his co-workers could sound bouncier by following a U.S. practice of announcing while standing-up. No matter the stance, Atlantic 252 jocks were empowered to emphasize the music and keep talk to a minimum.

Today [Summer 1996], the longwave music leader continues to offer: less talk than most other U.K. stations, national coverage, and, as their brochures

promise, "wide appeal with a fun, lively and lighthearted environment." Their playlist is formulated and honed by auditorium (focus group) and callout research. In addition to on-air contests, promotions include music festivals, print, direct mail, and even an Atlantic 252 motorcycle team. The results are impressive. Total Atlantic 252 listenership in the United Kingdom is larger than [late 1995 estimates] 5,600,000. Forty percent of that reach is in the 15-24 demographic, with another 65% of the audience between 25 and 44 years old. Just over half Atlantic 252 fans are female.

When the giant low-frequency outlet began in 1989, listeners in northern and western England (and throughout Ireland, of course) were likely the first to catch the signal. In fact, for these British folk far from London and other major cities) Atlantic 252 probably offered the loudest contemporary music on any dial.

No matter how you interpret the audience numbers, it's evident that in the U.K. there are lots of people listening to contemporary music under the traditional AM band. How come? Why is this happening to a station with no FM that has to compete with FMs? Granted, Atlantic 252 is huge, but so are a significant number of once legendary large-coverage American AMs, some just limping along.

1995 Research shows the U.K.'s Atlantic 252 is perceived as "fun, a friend, companion, and great source of entertainment." Perhaps we might conclude that when a radio station decides to play an important part in people's lives, it can successfully do so on AM, FM, or even Long Wave. That places great potential, and responsibility, in the hands of every broadcaster.

But What Happened To A-252?

That slice of UK radio history from the not-too-distant past can serve as a reminder about just how quickly the electronic media can change. A few years after the glowing piece was authored, Atlantic 252 noticed an audience decline, so it switched to a rhythm and dance format. By then (2000), more small com-



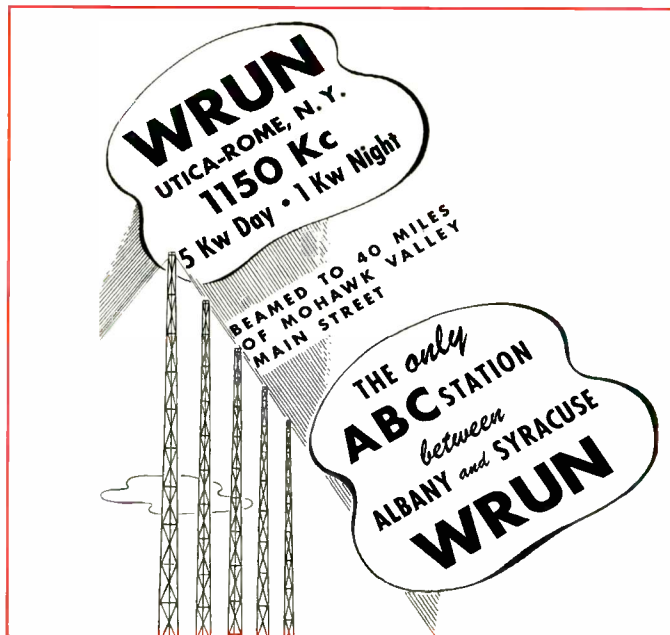

mercial FMs (and repeaters for some “national coverage” facilities such as Virgin Radio) had taken to the airwaves throughout the UK, subjecting the longwave/low-frequency station to serious audience siphoning. According to Mike Brown’s nicely arranged Atlantic 252 website at mb21.co.uk,

The reality of competition from other dance stations had meant falling revenue and listenership figures for Atlantic 252, and the station ceased broadcasting at the end of 2001 after an 80-percent stake in its parent company, Radio Tara Ltd., was controversially acquired by sports station TEAMtalk.

Brown indicates the longwave frequency was reactivated, though, and “rebranded TEAMtalk252, the station is now a sports channel, aimed mainly at a UK audience of 20- to 30-year-old males. It gives wider coverage to minority sports than is possible with any other channel” because of the 500-kW facility’s big footprint.

Taking Another Look In The Box

Along with the happenstance of that Atlantic 252 information falling at my feet, several other documents drifted in for this month’s column, including a winter 1967 QSL from WIBG in Philadelphia. The date leads me to believe my father pulled in the notable Top-40 outlet on his *Lafayette* communications receiver and longwire antenna. It was a vintage card even then, as, at the time of reception, “Wibbage” hadn’t occupied the depicted 1423-25 Walnut Street downtown studio for years. Walnut also served as *the* thoroughfare for popular Philly music stations with studios the public could view. WPEN at 2212 Walnut is another, and it hosted the original Bandstand teen-dance-in-the-studio program later transferred to WFIL and Dick Clark fame.

Notice how the engineer who signed the QSL penciled in “50000” under the printed “10,000 Watts,” suggesting the power increase had been granted after the cards produced. Those “five 250 ft. towers,” sent the WIBG signal Dad caught, but, contrary to the sketch, the related 990 kHz-active “transmitter [building] located in Montgomery County, PA,” was by then reconfigured to also house the studios and offices.

I once heard that striking WIBG picketers lining the long driveway to the studio/transmitter “shack” were chagrined when one of the rock-n-roll station’s highest-rated DJs was secretly spirited past them in the trunk of a speeding car in defiance of the angry union. By the way, WIBG began as a small religious station in suburban Philadelphia, with calls exclaiming “I Believe in God.” A quick google.com search should yield a number of wonderful sites devoted to this classic AM personality rocker which morphed into something called WZZD, *Wizard 100*, and then a Christian station starting in the late 1970s.

Forty Miles Of Mohawk Valley Main Street

Dick Clark’s 1976 book, *Rock, Roll, and Remember*, gives us an interesting perspective on a sheet of 1948 station publicity from a media market situated between Albany and Syracuse, New York. Clark’s uncle had recently started WRUN and WRUN-FM Utica when the flyer was printed. His father served as sales manager, and young Clark enthusiastically sought an opportunity to ply his then-teenaged tonsils on the AM/FM outlets. As he recalled,

One afternoon dad came out of his office and told me I would pinch-hit for a vacationing FM announcer. In those days, FM radio hardly existed; it wasn’t much more than a noble experiment. I didn’t care. This was my chance to get in front of the mike. I started out doing the weather forecast every hour on the FM. My listeners couldn’t have numbered more than seven or eight farmers, a couple of ducks, and a cow or two.

Clark laughs that he put an FM radio in the kitchen so his mother could listen to him. His father noted that the young announcer made the hourly outlooks “sound more like Shakespeare than the weather!” Clark later went to Syracuse University where he DJed on WOLF there, and did early TV work on Utica’s Channel 13, WKTV (now Channel 2). He was right about frequency modulation playing a minor role at WRUN. There’s not a single mention of the FM in the promotional piece.

Countin’ ’Em Down On Your AM Dial

Serendipity sailed one more radio history item into our pathway this month. It’s a 1971 year-end music survey from WICH Norwich, Connecticut. Someone compiling the roster had the logic to head the list with song #100 (“Lady Rose” by Mungo Jerry) and conclude the printed tally with Carole King’s “It’s Too Late” at number one. After all, it was a *countdown*. I’m guessing that no more than a few hundred of these leaflets were printed and distributed at some local stores and via the station reception desk. And the further out of Norwich one went, the more obscure these countdown papers would have been.

Even around 1971, though, there were still lots of mass appeal radio listeners who were indeed curious about their favorite song’s standing for the year. It wasn’t uncommon for the top tune to be discussed at New Year’s parties, the way a winning Super Bowl or World Series team might get some mention in small talk. Popular music wasn’t yet hyper-fragmented, so kids and old fogies alike had heard many of the same songs on the local airwaves.

The southeastern Connecticut station was rated in the Norwich/New London market, but pretty much had its home-

town sewn up radio audience-wise. In AM's heyday, WICH was nicely couched in its own little corner of the Nutmeg State. Competitors WNLC (suffering from a hyper-directional signal) and WSUB (daytime only), didn't make a big impact on Norwich contemporary music buffs. For some now-forgotten reason, the station selected 11 p.m. as its sign-off time. My folks tell me about attending a circa 1976 summertime outdoor Harry Chapin concert there, and drove to the event with WICH happily plugging the show and playing his hits. Chapin's stage show ended around 11:15, so the radio was just static when dad started the car to go back home.

The 5 kW-day/1 kW-night facility at 1310 ran separate antenna patterns day and night. It first took to the air in 1946. As our literature reveals, WICH employed a half-dozen cleanly dressed personalities to DJ its Top-40 (but not overly rocky) personality format. Even in the laid-back 70s, it was customary for announcers to be pictured in a jacket and tie.

Among the team counting down the top 100 hits of 1971 was Charley Ryan. A New Jersey native who got the radio bug as a teen, studied broadcasting, and headed to Connecticut in order to take an on-



BROADCAST PRO-FILE

28243 ROYAL ROAD
CASTAIC, CA 91384-3028

Complete radio station histories at a nominal cost.
Write for catalog.

air position with WICH, Ryan later became the Program Director of WNLC. According to my parents, he possessed a warm, friendly radio style that made for good listening.

Great Sounds Of DJ History On The Web

Before signing-off this time, I'd like to steer you to northeastairchecks.com, a wonderful website using free downloadable *Real Audio* to power the predominantly "scoped" (meaning the song centers are edited out) glimpses into the past. Webmaster and true radio buff, Rick Kelly, has posted dozens of airchecks you'll enjoy. I liked far too many to identify just one as a favorite, but, for me, the

regional weather roundup on the Northeast (FM) Radio Network (chronicled in February 2003 *Pop'Comm*) was something that brought that unique and otherwise long-defunct rural FM network to life.

Kelly constantly re-energizes the site by adding new airchecks each month. And, with the major air-personalities/legendary stations, he is careful to include a nice mix authentic slice-of-life local radio Americana—snippets of tiny locals that were typically staffed by enthusiastic novices aiming for a shot at the major markets. Accompanying narrative usually tells the stories about those who made it, as well as of those who loved radio too much to let it consume them.

And so ends another day of broadcast history at *Pop'Comm*...

better than ever

15 months of value.

CQ

2004/05 calendar

Amateur Radio Calendar for 2004/05!

15 months of spectacular images and hobby info for Only \$10.95

This year's calendar brings you 15 spectacular images of some of the biggest, most photogenic shacks, antennas, scenics and personalities. These are the people you work, the shacks you admire, the antenna systems you dream about!

This fifteen month calendar (January 2004 through March 2005) includes dates of important Ham Radio events such as major contests and other operating events, meteor showers, phases of the moon, and other astronomical information, plus important and popular holidays. This calendar is not only great to look at, it's truly useful too!

**Order today and be among the first to view these great images.
Calendars will ship to you on October 9th.**

Please note: We will not be offering a Classic Radio Calendar for 2004

1-800-853-9797 • FAX 516-681-2926 • www.cq-amateur-radio.com



CQ Communications, Inc.
25 Newbridge Road, Hicksville, NY 11801



Only
\$10.95 ea.
+\$2 s/h



discoveries connecting as a radio amateur

There's Nothing Like A Little Friendly Competition!

Now that fall is hinting at winter—at least in the northern climes—hams and SWLs do their best to ignore the weather extremes and focus on the season's improved propagation and easy (easier) DXing. Both are important to ham radio contesting, which is this month's topic. So, put on your winter underwear (or at least take off that ridiculous Hawaiian shirt), make sure your station and its antennas are in race-ready condition, and get set for several months of fun!

In case you're not familiar with ham radio's age-old tradition of friendly competition, and how it can benefit beginning operators, let's get a few definitions out of the way. Radio contests are usually on-air events in which hams work as many different stations as possible in a defined period of time (often a weekend). Depending on the particular contest, a premium is placed on working stations in different geographical regions (states, countries, ARRL sections, CQ magazine zones, grid squares, and islands, and so on) or stations with different callsign prefixes (KA2AAA, KB2AAA, KC2AAA, etc.).

These geographical regions or differing prefixes are called "multipliers." In the simplest sense, contest scores are determined by multiplying the number of two-way contacts (QSOs) by the number of multipliers (subject to the fine points of each particular contest, of course!).

When the dust settles, the contestants with the highest scores (there are usually several categories of competition, such as power level, number of station operators, and bands used) receive certificates or plaques and have their scores listed in CQ, QST, and other ham magazines.

Before Novices and Techs gained greater access to 10 meters (a bit more than a decade ago), most contest activity came from General, Advanced, and Extra class ops. That's not true today, however. Novices and Technicians have benefited greatly from their ability to work in part of the 10-meter phone subband (28.3 to 28.5 MHz), and there's a lot of contest activity there. In fact, the "Novice phone band" is a hot spot in many contests, including all of the big DX contests. Novices and Techs (and higher-class licensees) can work dozens of new states and countries while improving their operating skills as they progress.

Contest operating is fast and furious. Sometimes, thousands of signals from every corner of the globe are crowded into a relatively small part of the band. A typical SSB contest QSO may only last a few seconds. Ops exchange signal and location reports, and perhaps consecutive serial numbers or power-level identifiers. At first, the whole scene may seem overwhelming, but once you get your feet wet, you'll get the hang of it in no time.

Look at it this way: You could spend days looking for a Wyoming or New Hampshire contact to finish your Worked All States (WAS) Award, or you could work them both in one afternoon in the ARRL Sweepstakes contest. The same thing holds true for DX contacts and DX awards. Contesters regularly work all 50 states and 100 or more DX countries in one weekend by participating in the right contest! Although you may not finish your certificate's requirements in one sitting, you'll probably be amazed at your progress.

Checking Out 2.4 GHz



Made any 2.4-GHz QSOs lately? Well, I have, and I'm here to tell you that the DX is fabulous! In one evening I worked ops in Europe, Russia, New Zealand, and almost all of North America with just the antenna built into my compact microwave transceiver!

So, what's the catch? Well, I was chatting on the Internet, of course (2.4-GHz propagation doesn't quite work like 20 meters at the sunspot peak), with my laptop PC networked to my cable modem via a Compex WL11A 802.11b wireless networking card.

A Compex NP16 wireless router/access point doled out the bandwidth to the PCs connected to my Ethernet switch and managed the connection between itself and my laptop. I could roam all around the house, the backyard, and even the neighbor's barbecue gathering.

Using the laptop on the Internet was a no-brainer. I could in no way tell that the link was wireless. Thanks to the remote control software built into my SnapStream PVR (it's like a TiVo), I was also able to watch TV and recorded TV shows over the wireless link (although at less than DVD quality). Being untethered could become addicting!

The ham radio uses for 802.11b networks and transceiver technology range from networking the PCs at your next Field Day outing to sending remote video and audio in an emergency setting. You can also simply chat with other hams via 802.11b—with or without the underlying Internet infrastructure.

Although some details have yet to be worked out, it's clear that hams have at least a limited ability to use 802.11b technology at 2.4 GHz. Conveniently, amateur radio operators are the primary licensed users of that frequency band. I'll cover this maturing technology in an upcoming issue. In the meantime, check out the Compex website at www.cpx.com for more information on wireless routers and USB/PC card adapters.

Table HF Contests Beginners Will Enjoy

Month	Contest	Activity
Feb	School Club Roundup	All stations work all others
Mar	ARRL DX Contest, SSB	W/VE stations work DXCC countries
Mar	CQ WPX Contest, SSB	All stations work all others
Jun	ARRL Field Day	Mostly W/VE
Jul	IARU HF World Championship	All stations work all others
Oct	CQ Worldwide DX Contest, SSB	All stations work all others
Nov	ARRL Sweepstakes, SSB	W/VE stations work W/VE only
Dec	ARRL 10-Meter Contest	All stations work all others

The **Table** above lists several major contests that feature a lot of beginner participation. There are many more contests spread throughout the year. *CQ* and *QST* have monthly contesting columns, and many ham radio websites have contest listings, tips, and other useful information (see www.arrl.org/contests and www.contest.com for starters). These are good places to look for up-to-date contest information. The *ARRL Operating Manual* has plenty of detailed information on the fine points of contesting. It's a popular subject. When it comes to web resources, point your browser to www.contesting.com or www.arrl.org/contests and follow the links.

The extreme level of competition has driven some hams to erect gigantic antenna arrays powered by rows of dedicated amplifiers and top-of-the-line transceivers. Fortunately, ham radio contesting is productive and fun even with modest stations. That big-gun station in the South Pacific can pull your weaker signal through with ease. In that case, the contestant's top-notch station is working for you, too! Don't be afraid to enter the heat of the battle with only a transceiver and a simple antenna—the big-guns need you, and they have to listen for weak signals.

What About SWLs?

SWLs can have a lot of fun in ham radio contests, too. I can't think of any other time when there are so many signals emanating from exotic locations. In a big DX contest you can hear stations from every little nook and cranny of the globe, many of which you may never even have heard of! Island countries that have no (or very few) international broadcast outlets often support furious ham radio contest activity.

Many of these stations will send you a QSL card if you write to them and provide the details of one or more of their contest contacts. During SSB DX contests, listen from 28.3 to 28.7 MHz, 21.15 to 21.35 MHz, and 14.1 to 14.3 MHz during day-

light and early evening hours, and 7.05 to 7.25 MHz and 3.75 to 3.85 MHz during late-night hours for contest activity.

The best way to get comfortable with ham radio contesting is to simply get your feet wet. Be careful, though. Contesting can be extremely addicting. If you're like many hams, once you get started you won't want to stop!

What Interests You?

Want me to cover your favorite ham radio topic in "Ham Discoveries"? Write to me at *Popular Communications*, "Ham Discoveries," 25 Newbridge Rd., Hicksville, NY 11801. And why not send along your photo while you're at it?

See you next month! ■

Earn Your HAM RADIO LICENSE

The Quick, Easy Way!
No Morse Code Required!!

New for 2003-07



GWMT
\$15.95
+\$5 S&H

Learn from the "Master" – Gordon West, WB6NOA. Gordo has taught more people about ham radio than anyone! Get on the air and enjoy the fun hobby of ham radio. Book includes all possible test Q&A and much, much more. Start earning your Technician class license today!



NCS
\$39.95
+\$5 S&H

Get your license and be on the air quickly using our computer-aided course for the Technician class license. Includes Gordo's book and W5YI software with all possible test questions, answers, and explanations. Study at your PC for the FCC exam!

The W5YI Group

POB 565101 – Dallas, TX 75356
Order today on the web or call:
www.w5yi.org ♦ 800.669.9594

Want to know more about ham radio? Call us!
Mention this ad to receive a free gift with your order!

If you enjoy Amateur Radio, you'll enjoy *CQ*

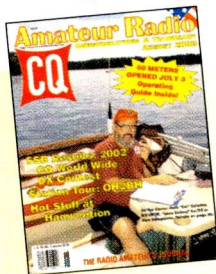

It's a different kind of ham magazine.

Fun to read, interesting from cover to cover, written so you can understand it. That's *CQ*.

Read by thousands of people each month in 116 countries around the world.

Here's a look at some of the articles we're working on for upcoming issues of *CQ Amateur Radio*:

Mobile Special in May!

"Simple Mobile Antennas for 10 and 15 Meters," by WA2KBZ

"How to Finish Up USA-CA," by KØZT

"CQ Reviews: ICOM IC-2720 Dual-Band FM Mobile," by WB6NOA

Plus . . . Results: 2002 CQ/RJ WW RTTY DX Contest

"Resonance," by K5YNR

"Power-Line RFI," by K5ZI

Do you have a ham radio story to tell? See our writers' guidelines on the *CQ* website: <<http://www.cq-amateur-radio.com>>.

	USA	VE/XE	Foreign
1 Year	31.95	44.95	56.95
2 Years	57.95	83.95	107.95
3 Years	83.95	122.95	158.95

Please allow 6-8 weeks for delivery of first issue

SUBSCRIBE TODAY!

CQ Magazine, 25 Newbridge Rd., Hicksville, NY 11801
Phone 516-681-2922 FAX 516-681-2926

Has The Cellular Industry Limited Customer Equipment Choices? And Is The FCC Cutting Off Availability Of GMRS Mobile Radios?

Our good friends at the FCC and the many captains of the telecommunications industry have certainly had their plates full in recent years. There has been more innovation in wireless communications in the last 20 years than perhaps in the entire previous history of radio, dating back to the 1890s. The numerous developments of recent history have hoisted our FCC Commissioners high into the glamorous political spotlight and have generated enormous wealth for the communications and electronics industries.

It has been a virtual gold rush to offer previously unheard of products and services to a public eager to be unshackled from wired telephones and the seemingly greedy monopolies that charged substantial recurring sums just to keep customers cordoned to a telephone nailed to a wall or a desk. Government and industry alike have promised—and continue to promise—greater consumer *choice* of products, services, and suppliers. Competition in telecommunications, both government and industry extol, is providing greater *choices* and lower pricing.

Why is it then that I can seldom get exactly what I want, especially in terms of product choice? And why is it that when I get whatever I must settle for (when I couldn't get what I wanted), that I still pay every bit as much, if not more, than I had in the past when what I wanted was available? And if I am feeling somewhat shortchanged as a communications consumer, then there must be hundreds of thousands—maybe millions—more who feel the same way.

The problem is not with all of the new products and services continually barraging the consumer marketplace. Instead, the problem is with what is being taken away from consumers. Every single product or service that is discontinued means one less *choice* for you and for me. We are again and again being “upgraded” to whatever is said to be “new and improved.” And regular readers here know the cold, hard truth I have repeated about *that* annoying oxymoron.

One item that is increasingly difficult to obtain, yet for which at least some level of demand remains, is the mobile telephone. I didn't say, “hand portable”; I said, “mobile.” I had stated only a few months ago in this column that true mobile cellular telephones are the choice of certain mobile professionals. These include over-the-road trucking company delivery vehicles, livery car and limousine services, government official staff cars, and, especially, mobile communications command posts. Why? There are several reasons. Chiefly however, these particular applications require mobile telephone apparatus that cannot become lost or misplaced. Mobile installations are far less likely to experience dead battery problems, as well.

Some of us would like to have true mobile phones ourselves. We may want them so we know where they are at all times; for instance, in the car, not left behind who-knows-where. Or we may want transmitter power that is five times higher than that of handhelds. Maybe we simply want handsets that actually fit



Is this a handheld video game? No, it's the Nokia 3300 wireless phone. Cool! This trendy fashion could possibly be the future of handheld telephone design. But, which end do you put to your ear when it rings? (All photos courtesy of Nokia)

our hands and our faces, with which the handset must interact. Whatever our reasons, this sort of product has been available for some 20 years, and should continue to be available to customers willing to pay for the product and its attendant service.

A recent *Pop'Comm* readers' poll (September 2002) asked about the desirability of having *mobile* telephones available for those who want them. A whopping 25 percent of respondents declared their desire to have permanently mounted mobile phones in their cars, trucks, or SUVs, if they could also have portable phones at little or no additional expense. If mobile units were available, this would not be a problem, since many wireless telephone service carriers already offer special “second line” and “two-for” deals.

Now, add to this another eight percent who flat-out don't want a low-power portable. These readers would rather have the full transmit power that can *only* be had with a mobile (and with the somewhat rare *transportable* or “bag” phones). Still another 12 percent would insist on having an installed mobile phone just to be certain that the phone is always right there where it belongs: in the vehicle!

A very significant 40 percent of respondents find the portability of a handheld phone just right for their use. They realize that handheld cellular phones work in the car just as well as anywhere else. These folks are satisfied customers. And that's good. Still, the 45 percent who indicated their preference for a true mobile phone may have to settle for something less than what they want, or do without, rather than pay for a product they don't really desire. (The remaining 15 percent indicated no interest in having a wireless phone. Could that possibly be because *they* can't find what they really want, whatever that may be?)

How has the wireless phone industry responded to this customer demand? *Responded?* Not at all, I'd say. Industry policy



Here's the stylish Nokia 3650. My own experience has been that Nokia produces only products of the highest quality. Still, will a visually challenged person find this handset's keyboard challenging to use?

from all wireless segments—broadcast, two-way, and telephones—has been essentially, “build it and they will come.” And they will buy. But no matter how many subscribers the wireless carriers may have, they are always looking for more customers. And in order to attract customers, whether from competitors or first-time users, wireless phone carriers and equipment vendors keep looking for more features to add to their subscribers’ phones or service.

We now have wireless phones that do e-mail. We have wireless phones that do instant text messaging. We have camera phones. Some handheld wireless phones have limited computing functions, such as word processing. Did those who are promoting all these whiz-bang features ever ask the public if they actually wanted them? Perhaps. But did they ask subscribers and prospective customers if they found any value in having an installed mobile phone? Obviously not.

Those of us who do have mobile telephones have, almost without exception, the original 800-MHz AMPS (FM) cellular phones (the politically correct term here is “analog,” for those who go in for such nonsense). We may have no particular desire to hold on to AMPS technology, but the fact is that “digital” mobile phones (TDMA, CDMA, GSM, etc.) are virtually nonexistent in the U.S. market.

And at this point in history, genuine AMPS mobile phones are no longer being offered.

In the very early days of TDMA service, at least one manufacturer made a dual-mode AMPS/TDMA mobile model. However, those early TDMA phones operated on the “old” standard, EIA/TIA IS-54. These phones have long since been phased out, and newer TDMA phones operate on the newer standard, ANSI-154. To my knowledge, only a few prototype ANSI-154 digital mobile units were ever produced, and most, if not all, of these have ended up in wireless testing laboratories, used for testing purposes.

In the earliest days of CDMA, Qualcomm produced a very few dual-mode AMPS/CDMA mobile telephones. These however, were not full 3-watt phones. Instead, they operated at the 1.2-watt level. Regardless, the few of these existed also appear to have ended up in testing laboratories, rather than in eager customers’ hands.

Any number of you reading this may be in the market for a new wireless telephone sometime in the not-too-distant future. If you’re a conscientious shopper, you’ll want to make up a prospective shopping list of features that you either *do* or *don’t* want to pay for in your new phone. Hey, it’s *your* money, and *you* are the customer! And just to check availability, let’s ask about an installed mobile phone. You may not want a mobile at all, I understand, but let’s just see what’s available. Say, you might just change your mind and go for a mobile anyway!

Okay. Go into any wireless phone dealer’s shop and ask about the availability of, or ability *not* to have, certain features. Here’s your list:

- Can I get a phone that actually fits my hand, please?

- How about a handset that fits my face? You know, one that actually comes close to bridging the distance between my ear and my mouth?

- Can I get a phone that is at least halfway professional looking? You know, something either plain black or dark gray that can be inconspicuously worn with a business suit or a uniform? No gaudy colors or cartoon characters, please.

- Is there any chance I can see a phone that actually looks like a telephone? Not one that resembles a flying saucer, a candy bar, or a handheld video game toy? (I’m really interested in seeing a wireless telephone that’s a phone, not a camera, not a computer screen, and with no text

MACO High Performance CB Antennas

For decades, MACO has meant high-performance CB base station and mobile antennas—made in the USA! Call us or visit our website for more information on our products.

- Base Station Antennas
- Mobile Antennas
- Cable Assemblies
- Mobile Hardware
- Power Supplies
- Accessories

Call or write for free catalog and name of reseller nearest you!

(800) 238-7258

MACO MANUFACTURING

4091 Viscount Avenue

Memphis, TN 38118

Ph. (901) 794-9494 Fax (901) 366-5736

www.majestic-comm.com/maco

SINGERS! REMOVE VOCALS
Unlimited Free Backgrounds
 from Original Standard Recordings!
Thompson Vocal Eliminator™
 VE-4 Free Brochure/Demo
 24 Hour Demo/Info Line
 (770)482-2485 - Ext84
 LT Sound Dept PC 7980 LT Parkway, Lithonia, GA 30058
www.VocalEliminator.com/g.o/PC
Better Than Karaoke For Over 25 Years!

POWERPORT IC-R5

Leather or Neoprene pouches!

New for the Icom IC-R5
 Beautiful glove leather with a spring steel belt clip or sporty neoprene in red or black. Well padded with water proof material.



STARTING AT \$14.49 800 206-0115 www.powerportstore.com

MOVING?

If you're planning a move in the near future, don't risk missing an issue of Popular Communications. Please give us 6-8 weeks notice if you're planning on changing your address. Just write your new address and mail it, WITH YOUR SUBSCRIPTION MAILING LABEL, to:

POPULAR COMMUNICATIONS
 25 Newbridge Road, Hicksville, NY 11801

FOR REALTIME LIVE STREAMING AUDIO

Visit the original
Action Radio Network
 New York & Las Vegas

Hear Fire, Police and EMS
 Departments In Action.

www.ActionRadioNetwork.com

messaging that spammers can attack relentlessly, day and night, at *my* expense.)

And of course, the real kicker:

- What choices of permanently installed mobile phones do you have to offer me?!

Go ahead and ask about any or all of these “features” that pertain to you, or about which you are simply curious. Ask, and be prepared for the blank stares and eyes rolling of sales folks walking right past you shouting, “Next!”

Whatever response you get, it will be pitiful and woefully inadequate. The sales personnel present may even try to make you feel that you aren’t quite up to speed with what is new and trendy. Trust me, though. Experience has shown me that the vast majority of sales and marketing folks in the wireless telephone world are largely clueless about the technology, the evolution and history of wireless, and sometimes even their marketplace. A senior sales associate in a wireless store may be one who has survived being on the job for more than just a few months!

So, if any of you do go shopping for a new wireless phone soon, and if any of these concerns listed above also concern *you*, I would like to hear from you. Cut out this article or make a copy of it, and take it with you when you shop. Please let me know what responses you get from sales people, and what level of success you achieve in actually getting (or *not* getting!) exactly what you want. Write to me at wpuc720@juno.com or by postal mail in care of the *Pop’Comm* offices at the address listed in the front pages of this magazine. If enough of you respond, I may write about your experiences in a future issue. We should be able to get what we want for what we pay, especially if what we want had already been available all along.

I have checked it out and, to this day, with our nation deep in the War on Terrorism, true mobile telephones with full-size handsets are still the units of choice in mobile command centers, communications vans, and in government officials’ limousines and cars. What will these agencies do when they are reduced to groveling for little four-inch candy bar phones that will inevitably be misplaced, dropped, and stolen? Only time will tell.

One more thing: If an unknowing salesperson rebuffs you about what you have read here, don’t let them even suggest that I’m just a journalist and don’t know what I’m talking about. I retired from cellular



The Nokia 9210i looks like a wireless phone, when closed. Open it up and see a computer-type keyboard and screen. This product is for those who really do want more than a telephone for their wireless service, and are willing to pay for such service.

network engineering just a couple of years ago. I have over 10 years experience in cellular technologies engineering alone, and I even have marketing experience, predominantly with one of the “Big Five” nationwide cellular and PCS carriers, at corporate headquarters. I’ve worked in the office, in the field, and in the laboratory—you name it!

For a time, I managed all network service quality issues for two area codes. And, I was a member of one of the several exclusive EIA/TIA standards-setting committees that shaped the wireless telephone technology that we have today. The work I did there is so proprietary that Title 18 USC (among other statutes) makes it a felony for me to even discuss it in any level of detail. Any marketing geniuses still want to take me on?

Coming: Availability Problems For GMRS Mobile Radios?

As if it isn’t bad enough that we can’t get a mobile phone if we want one anymore, we may one day have a similar problem with GMRS. Ever go shopping for a good GMRS *mobile* radio? Ever go shopping for any sort of GMRS mobile rig? Are there even any on the market? The short answer is, “no.” The long answer is a bit more convoluted. GMRS mobile radios are hard to find now, but they could become even scarcer in a few years.

The first factor is that no one manufactures or sells a dedicated GMRS *mobile* radio. Those of us who are using mobile radios in GMRS are using commercial-grade two-way radios primarily intended for occupational use in commercial ser-

vice or public safety dispatch operations as licensed under FCC Part 90 rules. Radio transceivers for use in either Part 90 or in GMRS (Part 95) must be *certificated* (formerly known as *type accepted*) by the FCC for use in those services. Radio manufacturers and importers naturally like to have their products as marketable as possible, so nearly all transceiver designs seeking Part 90 certification also ask for Part 95 certification, as well. The same principle applies to base stations, repeaters, and hand-portable radio transceivers.

We can see, then, that by using this sort of cross-certificated commercial-grade radio equipment, GMRS licensees do have a variety of mobile radio equipment from which to choose. But that will change. This past July, the FCC issued a long-anticipated Order that will split standard 25-kHz Part 90 land-mobile two-way radio channels to half their bandwidth (WT Docket 99-87; FCC 03-34). This of course will double the number of channels available to those radio services.

Yes, there will be a long transition period for those licensees; existing commercial licensees will have until 2013, and existing public safety licensees will have until 2018 to make the complete transition. However, in an effort to speed up this process, the FCC inserted a nasty little barb. The Order prohibits, starting January 1, 2008, the manufacture or importation of any Part 90 transceivers operating in any portion of the 150- to 174-MHz and 421- to 512-MHz bands *that are even capable of operating on the wider 25-kHz bandwidth!* Yet, the Commission has no such plans for GMRS.

There are a couple of considerations and probabilities here. One is that GMRS

licensees will no longer have *new* occupational radios available for use. Future Part 90 radio equipment will not meet GMRS specifications for authorized emission bandwidth. On the other hand, you may think that perfectly good used occupational radios, suddenly declared Part 90-obsolete by the FCC, will be dumped on the market at fire-sale prices, or even discarded free for the taking.

But wait! There remains a huge time gap at play. Think about it: new stock of "wideband" (25-kHz) radios is to be discontinued in 2008. But existing commercial licensees have until 2013 to actually make the changeover, leaving a five-year gap during which used radio equipment will only sporadically become large-ly and cheaply available. Existing public safety licensees have another five years after that, until 2018! There will be no overnight bonanza of good used radios in 2008, with a few sporadic exceptions of early adapters—not until 2013, at the earliest.

For the near-term, what are our options as GMRS licensees and system operators, including those considering building a new GMRS system? One is that as 2008 approaches, we acquire all transceiver hardware presently on the market, including repeater transmitting and receiving apparatus that we feel we will need for the foreseeable future, at least five years.

Well, even if we each had a crystal ball to see into the future, most of us just don't have the funds sitting around doing nothing with which to stock up on our own little warehouse. Hey, we're talkin' GMRS here, we're not commercial system operators! If we were, we'd be reading stuffed-shirt trade journals instead of entertaining and enlightening hobbyist and consumer-type magazines! (I write in those wireless trade journals as well, from time-to-time. Well, I did until that last remark of mine!)

Another option for the future is to search diligently for those

used occupational radios that will, if only now and then, come onto the market after 2008. And, in so doing, we can hope for the best. But GMRS licensees won't be the only ones waiting to snatch up used occupational transceivers. Operators of 25-kHz-wide occupational two-way equipment who are not quite ready to make the switch to narrowband may also need used equipment. This would be to replace older radios that are totally shot, when new 25-kHz-wide transceivers are no longer available.

There is a third option, for which we can only hope—so far. That is for manufacturers to produce true mobile, base, and repeater radio equipment specifically for GMRS. Although this is only wishful thinking right now, this could actually happen. In fact, its time had come quite a while ago. Here's why.

Since none of the occupational radio equipment being used in GMRS is designed with total GMRS functionality in mind; there are compromises to begin with. For one thing, commercial radios might as well be rock-bound. Not too many years ago, all such radios were crystal (hence "rock") controlled for frequency and used electromechanical reeds for CTCSS (tone squelch) control. Over the last several decades or so, frequency control and code control squelch have gone entirely electronic and have become software or firmware defined. Either way, older technology or newer, occupational radios must be *pre-configured* or *pre-programmed* before being put into use.

Commercial and dispatch radio systems use a specified, and sometimes very limited, number of *assigned* frequencies. However, since certain FCC rule changes occurred, circa 1998, GMRS licensees now enjoy access to all 15 GMRS channels (23 frequencies: eight paired duplex and seven low-power simplex). Therefore, a GMRS mobile radio should have access to all channels, including both repeater and simplex (talkaround)

If it's on the air, it's in

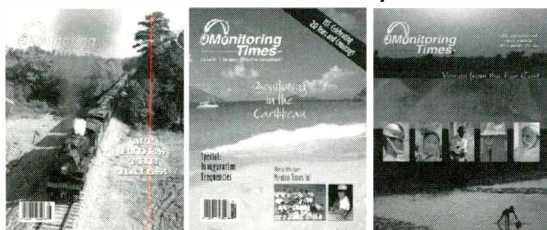

Are you interested in listening to distant ports of call? Exciting police and fire messages? Ham Radio? Emergency medical communications? Air-to-ground comms? Building home electronics projects? Then Monitoring Times® is your magazine! Open a copy of MT, and you will find 92 pages of news, information, and tips on getting more out of your radio listening. In fact, it's the most comprehensive radio hobby magazine in the U.S.

Packed with up-to-date information concisely written by the top writers in the field, Monitoring Times® is considered indispensable reading by government and newsgathering agencies.

Here's what you'll get with a subscription to MT, every month:

- International broadcasting program schedules
- Shortwave and longwave DXing
- Satellite broadcasting
- Pirate and clandestine stations
- Two-way communications monitoring
- Listening tips and insights from the experts
- Frequency lists
- News-breaking articles
- Exclusive interviews
- New product tests and book reviews
- ...and much, much more!



MTXRESS

For less than the cost of a subscription in the U.S., you can be reading the entire Monitoring Times magazine anywhere in the world before U.S. subscribers receive their printed copies! MT Express is the downloadable version of the exact same magazine that has gained a worldwide reputation for reliable radio information that's easy to understand, and products and projects of proven value.

For a mere \$19.95 U.S., **MT EXPRESS** gives you Monitoring Times magazine

- In PDF format viewable with free software
- Delivered by FTP (10 MB file)
- Viewable in brilliant color on your computer screen
- Easily navigated by clicking on the Table of Contents
- Printable using your own computer printer
- Searchable to find every mention of a topic or station schedule
- Importable into your frequency databases
- Compatible with software to convert text to audio for sight impaired listeners

One year subscription to **MT EXPRESS**—only \$19.95, or for even greater savings, \$11 in addition to your printed subscription.

Subscribe to MT for as little as \$14.50 (U.S. Second Class Mail)

7540 Hwy. 64 W., Brasstown, NC 28902
1-800-438-8155 US and Can.; 828-837-9200; Fax 828-837-2216
e-mail order@grove-ent.com

	6 months	One Year	Two Years	Three Years
US Rates	↘ \$14.50	↘ \$26.95	↘ \$51.95	↘ \$76.95
US 1st Class	↘ \$30.00	↘ \$57.95	↘ \$113.95	↘ \$169.95
Canada Surface*	↘ \$21.50*	↘ \$39.50*	↘ \$75.95*	↘ \$112.95*
Foreign International*	↘ \$30.50*	↘ \$58.50*	↘ \$114.95*	↘ \$171.50*
Electronic Subscription		↘ \$19.95	↘ \$38.90	↘ \$57.85

*All payments must be in U.S. Funds drawn on a U.S. Bank!



mode on the duplex channel pairs. And the operator should have the ability to change CTCSS and DCS tones on-the-fly.

These are just the minimal requirements for a GMRS transceiver. We'll take a closer look at some desired features that would be found on a well-designed, dedicated GMRS mobile transceiver, next month.

CH-1 Internet "E-Zine" For FRS Debuts

An announcement from the *News Desk* of GMRS expert Wayne Barringer, KB6UJW/KAGØ37Ø, notes that, "After many 'spits and spurts'—it's finally online. The first issue of *CH-1* is available right now at <http://www.f-r-s.org/e-news/ch-1/F-R-S.org,ch-1.2003-07,01p01.txt.htm>." It really is "off the press," since this is a Web-based electronic magazine, or *e-zine*. *CH-1* focuses entirely on FRS communications. Wayne points out that this isn't a product review source, but a reference source for ideas on using FRS in a "local" setting. Set your browser to *CH-1* and check it out today!

The 2004 Annual CB-Radio-List Competition!

Get ready for the upcoming CB radio competition hosted by the CB-Radio Yahoo Group, cbradio@yahoo.com. List master Keith Thews has announced that the contest is set for the weekend of January 17 and 18, 2004, and will run for the 24 hours from 2 p.m. EST (19:00 GMT/Z) that Saturday to 2 p.m. (19:00 Z) Sunday.

Keith says that the rules are simple: Contact as many people as you can in those 24 hours! The individual making the most logged contacts wins. There are two contests from which to choose: the 40 legal AM channels and sideband within those channels. Please note that this is a legal contest. Contestants are to keep their contacts within the 155-mile CB distance-of-communications limit, and only legal power limits are to be used.

To sign up for the contest and to see the complete official rules, become a part of the CB-Radio Yahoo Group. Log onto <http://groups.yahoo.com/group/cbradio>. The group notes that additional support for this contest is being provided by Michiana CB Emergency Service and by Advanced Storm Spotters and Chasers. This contest is only two months away from the date of this *Pop'Comm* issue, so start preparing now!

Channel Masters CB Club Is Getting Squirrely!

Well, sort of. The venerable Internet CB club has morphed into the *White Squirrel CB Radio Club*, according to Robert Nicholas, "The Nashville Rebel." See http://groups.yahoo.com/group/White_Squirrel. Will the previous Channel Masters name and group live on as well? Go to <http://groups.yahoo.com/group/channelmasters> and see. As of press time, we don't yet know for certain. Be sure to check out both websites for yourself.

Channel Masters had attained nationwide recognition over the past year or so. Their efforts in using Internet e-mail to alert members nationwide whenever there was a need to locate a mobile CBer, in order to relay an emergency message, have proven effective, hence the well-deserved attention. We will have to watch and see what the future holds for the White Squirrel CB Radio Club and for the old Channel Masters name.

New USA RSN CB Radio Group Begins

The world-known RSN CB radio group has started a USA Group net call-in every Friday night at 8 p.m. Pacific Daylight Time. (That's the way we received this information. Should be 03:00 GMT/Z.) Check <http://www.timeanddate.com/worldclock> to coordinate with your own local time zones. Group President and Founder Janne, 21RSNØØ1, invites all to listen in on their worldwide radio check on 27.505 USB or LSB. His worldwide group, headquartered in Sweden, can be visited at <http://w1.504.telia.com/~u50405985/>. And the official U.S. website for RSN is at <http://www.webspawner.com/users/dsemograd>.

Before you folks start sending in letters chastising us for promoting illegal CB or outband radio operation, please note that most nations other than the United States have no 155-mile DX limit on CB communications. Additionally, CB channelization in *some* other countries is entirely different than it is in the United States. Remember, Janne's invitation to U.S. CB operators and SWLs is, in his own words, to "see what they can hear."

Nextel And The Truth About "Push-To-Talk"

In the September issue of *Pop'Comm*, you learned that Nextel had registered the very common term "Push-To-Talk," presumably to promote their SMR (Special Mobile Radio) walkie-talkie service. What does this mean for hobbyists and consumers? For a precise answer from a legal expert, I asked Alan Tilles, Esq., a telecommunications attorney specializing in land mobile with the Washington, D.C. area law firm Shulman, Rogers, Gandal, Pordy & Ecker. Here's what Alan T. says:

Nextel's registration of "push-to-talk" is on the Patent and Trademark Office's *Supplemental Register*. The Supplemental Register may be used by registrants when a registration on the Principal Register is refused. This is typically done where the mark is *descriptive* of the goods or service, which is most likely the case here.

Descriptive marks cannot be registered on the Principal Register unless or until the mark becomes distinctive of that company's goods or service. A *Supplemental Registration* conveys none of the legal protections normally associated with a Principal Registration, nor does it prevent other prior-in-time users from continuing to use these *descriptive words* to describe their own goods or service. [Emphasis added.]

We can see now that we need not fear uttering what some have regarded as a newly forbidden phrase. You won't face a grand jury indictment because you mentioned your radio's "push-to-talk" feature to colleagues at a local club meeting. The police will not be knocking at your door for merely mentioning the phrase in your Internet e-mail or on the air over your local repeater system. And no lawsuit will strip you of all you own simply for possessing non-Nextel radio equipment that has "PTT" stamped on the mic transmit button. Unless you are a manufacturer of marketer of wireless equipment or services, this sorry matter is essentially a non-issue.

More To Come...

Well, that sure takes a load off of my mind! Let's join up again right here, next month. Then, we can take a closer look at GMRS, as well as other *personal radio* news coming our way. For CB, FRS, MURS, and wireless telephones news, "On-The-GO Radio" is for you. See you in chilly December! ■

the Pop'Comm

by Eric Force, eric@dobe.com

puzzle corner *test your radio knowledge*

(RevSp = Reverse Spelling – e.g. "SPELLING" = "GNILLEPS" in puzzle)



ACROSS

- 1 Type of transistor
- 4 Type of directional antenna
- 8 Bark sharply
- 11 Decimal ASCII 65, 84, 65
- 12 Investigates transportation accidents (U.S.)
- 13 Cell phone feature
- 15 dah dit dah dit, dit dit dit, dit dah dah dit
- 16 Defines a chemical element
- 17 Broadcasts airport weather conditions
- 18 "Ground" wire color (RevSp)
- 20 To gain knowledge
- 21 Airport, Albany, NY
- 23 Airport, Honolulu, Hawaii
- 24 Callsign, General Aerospace, Inc.
- 28 Heat sink and fish feature
- 31 "Motor" abbreviation
- 32 Prevents FM receiver drift (abvr)
- 33 aka MW band
- 34 CW abbr, About
- 35 Science of heard sounds (RevSp)

- 38 AM 1220, Cleveland, Ohio, U.S.
- 39 Unit of electrical resistance
- 40 Callsign, Business Express (RevSp)
- 43 Aircraft reporting system
- 47 Telephone keypad "0"
- 48 AM 1340, Amos, Quebec, CA
- 51 Exclamation of disbelief
- 52 Matured fruit
- 53 Hawaii Airport ITO
- 54 Automotive computer device (abvr)
- 55 aka Hertz (abvr)
- 56 Gush
- 57 Singing cowboy Ritter's first name (RevSp)
- 20 Lao National Radio & Television
- 22 Resistor color code 0
- 23 Prefix 10E2
- 24 Threaded, coaxial signal connector - usable to about 26 GHz.
- 25 Kazakhstan Television & Broadcasting Corporation (Abvr)
- 26 Yugoslav Radio-Television (Abvr)
- 27 AM 640, Los Angeles, CA, U.S.
- 28 Airport-based business
- 29 201 as Roman Numeral (RevSp)
- 30 Basketball association (abvr)

DOWN

- 1 The "P" in AN/PRC-6 (Mil)
- 2 USA broadcast standard
- 3 Phonetic dit dah dah dit
- 4 NY Airport ALB (RevSp)
- 5 Often expressed in dB of reduction (abvr)
- 6 Airport, Greensboro, NC
- 7 Famous for the "Selectric" Typewriter
- 8 Pop' Comm Assistant Production Mgr (RevSp)
- 9 Islands On The Air (abvr)
- 10 "Twisted _____" (type of wiring)
- 14 Microsoft's "Butterfly" promotes this
- 19 "Ohm's ____"
- 35 First bank established in the Kingdom of Saudi Arabia (abvr)
- 36 Callsign, Air Exel Belgique
- 37 NYSE Symbol: United Microelectronics Corp.
- 38 Metal threads
- 40 Digital circuit logic gate
- 41 Heroic
- 42 End-fed antenna
- 44 Callsign, Airborne Express
- 45 Wire run
- 46 Close
- 48 Calculator key "Change Sign" (abvr)
- 49 60's He's "with it"
- 50 Malt beverage

(Solution on page 80)

THIS MONTH IN RADIO HISTORY "CW Code" On November 2, 1920 ... (Hint: Think Letter-1)

T U B U J P O L E L B , M P D B U F E J O
 - - - - - ' - - - - -
 Q J U U T C V S H I , Q F O O T Z M W B O J B ,
 - - - - - ' - - - - -
 N B E F U I F O B U J P O \ T G J S T U
 - - - - - ' - - - - -
 D P N N F S D J B M C S P B E D B T U .
 - - - - - ' - - - - -

Solution: Station KDKA, located in Pittsburgh, Pennsylvania, made the nation's first commercial broadcast.

Pop'Comm Trivia...

Since 1997 I have provided online guides to useful electrical and electronic information including electrical terminology, definitions and acronyms. I also point the way to real information on electrical and electronic related topics.

What am I?

Answer: Alex's Electronic Test Bench. More info at: <http://www.iserv.net/~alex/index.htm>

FREE! "Where's That Station" PC Program - Check It Out! - <http://www.dobe.com/wts/>

Radio Trouble In Costa Rica

Things are not very peaceful on Costa Rica's shortwave scene these days. It seems the University For Peace, which hosts the facilities of Radio For Peace International, has locked station personnel out of the property and, in a bit of delicious irony, placed armed guards at the gates.

At this point it seems the disagreement centers on \$14,000 the University claims the station owes for computer and telephone equipment. There may also be a philosophical, political, or personality conflict with a new university administration, which took over sometime ago. RFPI is pleading with its listeners to write protest letters to UN Secretary General Kofi Annan (the university operates under a UN mandate).

As this is being written RFPI was still broadcasting (evenings on 7445), running programming featuring interviews with General Manager James Latham giving RFPI's side of the story, but it was approaching a university-imposed deadline. More than likely the dispute will have been resolved by the time you read this. We should have more on this on-going unusual situation in next month's column.

Not long ago we reported that **Radio New Zealand International** had been forced to cut power by 50 percent to save electricity. But now we get the truly wonderful news that this great station is operating 24 hours a day. A new service, "Dateline Pacific," focuses on Pacific news and its output will be included in some of the station's shows as well as in specific newscasts emphasizing news from that area.

Some distance down the road we may start seeing some positive changes at **Radio Centrafrique** in the Central African Republic. They've received a bunch of money from Japan to use to fix up their broadcast facilities. Frankly, we're uncertain as to whether their shortwave outlets (**6100** and **7220**) are even active, so perhaps this flood of francs they're receiving will reinstate or improve signals from Bangui.

Another upgrading project is underway at **Radio Havana Cuba** (not that it's needed!). Many of their shortwave frequencies have suffered from low modulation, hums, distortion, etc. You have to wonder, though, where the money is coming from!

Radio Yugoslavia has now switched fully to its new name, International Radio of Serbia and Montenegro. We mentioned this last time, but then they were still in the process of phasing out the old usage. They also ID as "RSCG" (Radio Srbija a Crna Gora in Serbian).

Another Central American station has reactivated. **Radio Universidad de Costa Rica** is operating from San Jose on **6105**. This 2-kW station was formerly scheduled from 1300 to 0600, though we don't know if either the schedule or the wattage still holds. In any event, you'll likely have problems getting this one since there's a lot of action on this frequency.

That new station that High Adventure Ministries planned to put on from Liberia has been scratched, very likely a victim of the seemingly endless civil wars that have been going on there for several years now. Liberia is not a good choice, as other broadcasters have learned in painful fashion. But HAM hasn't

feba radio
broadcasting hope for 30 years

Subject: FEBA RECEPTION REPORT
Date: 7/1/2003 3:36:44 AM Eastern Standard Time
From: "Brooke, Angela" <ABrooke@feba.org.uk>
To: "Rdangelo3@aol.com" <Rdangelo3@aol.com>
Sent from the Internet (Details)

Dear Mr d'Angelo

Thank you for your e-mail. It's good to know that you were able to listen to this Spotlight programme.

However, Feba no longer owns its own transmitting station, and I regret that we are no longer able to verify reception reports and provide QSL cards. The difficulty is in verifying details of each broadcast, as they are now broadcast in language blocks by a service provider, who is unable to do this for us.

I am sorry to disappoint you and hope that you will nevertheless continue to be blessed as you listen to Christian radio.

With best wishes

Angela Brooke
Supporter Relations

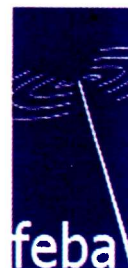

Feba, Ivy Arch Road, Worthing, W Sussex, BN14 8BX
Tel: 01902 237281 Fax: 01903 205294
E-mail: abrooke@feba.org.uk

The Far East Broadcasting Association, which used to transmit from the Seychelles, now has no transmitters of its own—which it finds is a handy excuse to discontinue QSLing. (Thanks Richard D'Angelo)

tossed in the towel—instead of Liberia, High Adventure will put the station in Uganda. It will focus its broadcasts on the Middle East.

It seems that no one—not even employees—knows what the QSL policy of the Far East Broadcasting Association is now. FEBA was an excellent verifier until they discontinued their operations in the Seychelles. But now, with programs carried by other stations, they are uncertain about what airs when or where, and they feel it would take too much time and effort to check reports. The overall flavor of several e-mails Richard D'Angelo (PA) has been exchanging with FEBA offices in Cyprus and the UK doesn't seem very positive for further replies from this once superior organization.

This month's book winner is **Robert Brossell** of Pewaukee, Wisconsin. Bob receives a copy of the 2004 edition of *Passport to World Band Radio*, courtesy of Universal Radio. His package will also include a copy of Universal's giant wish book (sometimes called a catalog) that's crammed with radios, antennas, accessories, books, and whatever for whatever radio interest you have. You can get a copy by calling 614-866-4267 or dropping a note to Universal Radio, 7830 Americana Parkway, Reynoldsburg, OH 43068.



Radio Roma, now RAI Int'l, issued this neat photo card back in 1962!



QSL
RADIO
THAILAND
WORLD
SERVICE

Broadcast Schedule

GMT	Service
00:00	01:00 English
01:00	02:00 Thai
03:00	03:30 English
03:30	04:30 Thai
11:00	11:15 Vietnamese
11:15	11:30 Khmer
11:30	11:45 Lao
11:45	12:00 Burmese
12:00	12:15 Bahasa Malaysia
12:15	12:30 Bahasa Malaysia
13:00	13:15 Japanese
13:15	13:30 Mandarin
13:30	14:00 Thai
18:00	19:00 Thai

One of the numerous waterfalls in Thailand. Photographer: Sonchai Nguansa-ngiam

Broadcasting at the frequencies of 4830, 6020, 6045, 6185, 7140, 7205, 7215, 7225, 7235, 7245, 7255, 7285, 7290, 9510, 9530, 9535, 9540, 9555, 9615, 9635, 9640, 9645, 9655, 9685, 9690, 9705, 11725, 11735, 11755, 11780, 11805, 11820, 11885, 11905, 11920, 15265, 15370, 15430, and 15445 kilohertz in accordance with required time, target areas and weather conditions.

Radio Thailand is a lot more easily heard in North America, now that it is using the Voice of America's relay transmitters.

Abbreviations Used In This Month's Column

- // — Parallel frequency
- ABC — Australian Broadcasting Corporation
- AFRTS — Armed Forces Radio Television Service
- AFN — Armed Forces Network
- AIR — All India Radio
- anncr — announcer
- anmt(s) — announcement(s)
- BSKSA — Broadcasting Service of the Kingdom of Saudi Arabia
- CNR — China National Radio
- GOS — General Overseas Service
- ID — identification
- Int'l — international
- IS — interval signal
- Lang — language
- LSB — lower sideband mode
- NBC — National Broadcasting Corporation
- OA — Peru, Peruvian
- PBS — People's Broadcasting Station
- Pgm — program
- RRI — Radio Republik Indonesia
- sked — schedule
- SIBC — Solomon Islands Broadcasting Corporation
- TOH — Top of the Hour
- unid. — unidentified
- USB — upper sideband mode
- vern — vernacular (any local dialect or language)
- VOA — Voice of America
- VOIRI — Voice of the Islamic Republic of Iran

ARMENIA—Voice of Armenia, **9960** at 1939 with IS, anthem, ID, schedule, and "Top Stories." (Burrow, WA)

ASCENSION ISLAND—Radio Japan relay, **21630** at 1537 with call-in program in JJ. (Foss, Philippines)

AUSTRALIA—ABC Northern Territory Service, Alice Springs, **2310** at 1812 with Hank Williams song. (Foss, Philippines) Radio Australia, **5995** at 1435 with talk. (Burrow, WA) 0717. (Miller, WA) **6020** at 1225 and **9580** at 1420. (Northrup, MO) 6020 at 1133 and **12080** at 1100. (Barton, AZ) **9710** in Pidgin at 1030. (DeGennaro, NY) **11650** at 1211. **15515** at 0207. **17580** at 0150, **17715** at 2221 and **17795** at 0040. (Jeffery, NY) **15240** with music, ID at 0200. (D'Angelo, PA) **15415** at 0705 with news, ID "You're listening to Pacific news with Radio Australia." Also **21740** at 2120 on medical negligence. (Wood, TN) 15515//17580 at 0333. (Brossell, WI) 15515 at 0510. (Moser, IL) 21740 at 2135. (MacKenzie, CA) (Think we got that covered?—gld)

AUSTRIA—Radio Austria Int'l, **13730** in GG at 1210. (Brossell, WI) FEBA via Austria, **9465** from 0028 sign-on with IS and into "Spotlight" program. Language change at 0045. (D'Angelo, PA)

BELARUS—Radio Belarus, **7210** heard from 0200 sign on with IS, multi-lingual ID, news in EE. Parallel to **5970**. (Alexander, PA)

BELGIUM—Radio Vlaanderen Int'l. **9865** (via Russia) at 1155 with IS and into DD at 1200. (Barton, AZ) **15565** via Bonaire at 0315. (Miller, WA)

BENIN—Radiodifusion du Benin, **4870** in FF at 1018. (Miller, WA)
BOLIVIA—Radio Nueva Esperanza, **6585.4** in SS with talk, anthem and off at 0134. (D'Angelo, PA) Radio San Jose, **5580.2** in SS at 0000-0100. (Wilkner, FL) Radio Yura, **4716.8** at 0058 with slow romantic tunes, woman anncr with brief talks. (Montgomery, PA)

BOTSWANA—Radio Botswana, **4820** at 0215 apparently on early with man hosting program of local music, lively talks in Setswana, mentions of Gaborone, and IDs at 0242 and 0253. (D'Angelo, PA) 0315 with U.S. rhythm and blues. (Linonis, PA) VOA relay, **15445** with "Jazz America" at 2115. (Brossell, WI)

BRAZIL—Radio Anhanguera, **4915** in PP at 0230. (Paszkiwicz, WI) Radio Difusora Londrina, **4815** at 0247 with songs, PP talks, and

Now here's the usual plea for your informational support in the form of your loggings (by country, double spaced, with your name and state after each), photos of you in your shack, schedules, spare QSLs or clean crisp copies, or station pictures. We welcome whatever you think might be of interest!

Here are this month's logs. All times are in UTC. AA, FF, SS, etc. are language abbreviations (Arabic, French, Spanish). If no language abbreviation is indicated, the broadcast is assumed to have been in English.

ALBANIA—Radio Tirana, **6115** with news at 0145. (Paradis, ME) **6116/7160** heard at 0247 with various features to sign off at 0256. (Burrow, WA)

ANGOLA—Radio Nacional, **4950** at 0000 with four pips on the hour, man with apparent ID and news items, another ID at 0003. (Montgomery, PA) 0343 with easy listening music, five pips on the hour, ID. (Paszkiwicz, WI)

ANGUILLA—Caribbean Beacon/University Network, **11775** at 0911 with Gene Scott. (Barton, AZ)

ARGENTINA—RAE, **11710** at 0200 with ID, schedule, frequencies, and into programming. (Paradis, ME) 0212 with Argentine music, "News from Buenos Aires." (Burrow, WA)

ID. Off around 0258. (D'Angelo, PA) Radio Clube do Para, **4885** in PP at 0230. (Paszkiwicz, WI) Radio Clube Paranaense, **6040** in PP at 0145 with fast talking man in PP. ID, frequency on the hour, two men talking over instrumentals. (D'Angelo, PA) 0238. (Paszkiwicz, WI) Radio Brazil Central, **4985** at 0131 with big band music—perhaps Saturday evenings only, man in PP with talk and music in background. (Montgomery, PA) 0230. (Jeffery, NY) **9245**. (Paszkiwicz, WI) 0510. (Miller, WA) Radio Rio Mar, **9695** at 1025 with ads, PSAs in PP. (DeGennaro, NY) Radio Capixaba, **4935** with sports event at 0110. (Strawman, IA) Radio Nacional Macapa, **4915** in PP with news discussion at 0431. (Miller, WA) Radio Cancao Nova, **9675** at 1023 with religious programming in PP. (DeGennaro, NY) 0300. (Paszkiwicz, WI) Radio Bandeirantes, **9645** in PP at 0302. (Paszkiwicz, WI) Radio Nacional, **11780**, 2032 with news in PP. (DeGennaro, NY) 2200 up-tempo LA music. (Wood, TN) 0235 with news in PP. (Miller, WA) 0300. (Burrow, WA) 0320. (Paszkiwicz, WI)

BULGARIA—Radio Bulgaria, **9400** at 2300 with news and discussion on corruption in the judiciary system. (Paradis, ME) 9400//**11900** at 0215 on Bulgarian economy. ID at 0218. (Burrow, WA) 11900 with sports at 0230. (Quinby, PA) 0232 with history feature. (Miller, WA)

CANADA—Radio Canada Int'l, **17870** at 2008 with "Maple Leaf Mailbag." (Wood, TN) **17880** in SS at 2231. (Barton, AZ) CFRX relay CFRB, **6070** at 1415. (Northrup, MO)

CHILE—Voz Cristiana, **11935** with Christian rock in SS at 1211. (Barton, AZ) **15100** in SS at 1928. (Miller, WA)

CHINA—China Radio Int'l, **9790** at 0100. (Quinby, PA) **11880** from X'ian in SS at 2324. (Foss, Philippines) **13650** via Cuba at 2330. (Barton, AZ) Xinjiang PBS—Urumqi, **6120** at 1543 with EE lesson. (Foss, Philippines) Xizang PBS, Lhasa, **5935** in CC at 1540. (Foss, Philippines)

COLOMBIA—La Voz del Guaviare, **6035** at 0947 with non-stop LA vocals, SS ID and frequency anmt at 1000. (D'Angelo, PA) Radio Nacional, **9635** in SS with music to 0500 close. (Miller, PA) Voz de su Conciencia, **6010** at 0842 with SS talks and music, canned ID by woman at 0844. (Montgomery, PA)

CONGO—Radio Congo, **5985**, 2210 in FF and local dialect with talk and music. (Ziegner, MA) 2246 in FF and brief FF pop vocal segments. Also at 0443 with lively high-life vocals. WYFR marred reception at 0455. (D'Angelo, PA) 0615 in FF with tentative ID, into music. (Linonis, PA)

CROATIA—Voice of Croatia, **9925** via Germany, 0300 in SS, EE. (Paradis, ME) 0304 in unid language with ID, anthem, talk. (Burrow, WA) 0410 with national music. (Miller, WA)

CUBA—Radio Rebelde, **9600** at 1100 with SS talks. (DeGennaro, NY) Radio Havana Cuba, **6000** in SS at 1220. (Northrup, MO)



"Letters, we get letters," and REE used a selection of them on a QSL issued back in 1997.

11760 in SS at 0130 with anti-U.S. talk. (Quinby, PA)

CYPRUS—BBC Relay, **9410** heard at 2111 with pops. (Brossell, WI)

CZECH REPUBLIC—Radio Prague Int'l, **9870** at 0257 with schedule, ID, IS at 0259, and into news at 0300. (Burrow, WA) **11600** with news at 2230. (Paradis, ME) **13580** in FF at 1842. (Foss, Philippines) **15620** at 0354 with ID "You are listening to Radio Prague in the Czech Republic." (Brossell, WI)

DENMARK—Danish Radio, **9475** via Norway at 0451 with DD news and off at 0456. (Miller, WA)

DOMINICAN REPUBLIC—Radio Cristal, **5009.7** at 1028 with anthem, "la emisora Radio Cristal, en todos el pais...transmite..." Many mentions of Santo Domingo. (Wilkner, FL)

ECUADOR—HCJB, **6050** in SS at 1145. (Northrup, MO) **11920** in SS at 0140. (Quinby, PA) **15140** with music at 1330. (Barton, AZ)

EGYPT—Radio Cairo/Egyptian Radio, **9475** at 0315 with Middle Eastern music. (Barton, AZ) **9990** at 2125 with music, talk. (Burrow, WA) 2138 on wrapping a mummy. (Ziegner, MA) **11725** in AA at 0307 and **12050** in AA at 2005. (Brossell, WI) 2050 with talk and music drop-ins. (DeGennaro, NY) 2245 with AA music. (Miller, WA) 0140 in AA. (Quinby, PA) **17800** in AA at 1315. (Northrup, MO)

ENGLAND—BBC, **15450** in Somali at 1800. (Ziegner, MA) Adventist World Radio via England, **17660** in Igbo to Nigeria at 1933. (Watts, KY)

FINLAND—YLE/Radio Finland, **15400**, //17670 with news in apparent FF at 1200. (Brossell, WI)

FRANCE—Radio France Int'l, **11710** with EE to West Africa heard at 0600. (Linonis, PA) **11950** via Gabon in FF at 2045. (DeGennaro, NY)

FRENCH GUIANA—Radio France Int'l, **17630** in SS at 2106. (Barton, AZ)

GABON—Africa Number One, **15475** in FF at 1633 with FF talk, rap, and high-life. (Brossell, WI; Ziegner, MA) RFI relay **4890** in FF at 0415. (Paszkiwicz, WI) **15615** with EE news at 0716. (Wood, TN)

GEORGIA REP.—Radio Georgia, **11805** heard at 0446 with news in unid language. (Miller, WA)

GERMANY—Deutsche Welle, **11925** (via Portugal—gld) at 0500 with EE news. Also **11970** (via Antigua—gld) at 0505 with news in GG. (Moser, IL) **15410** via Rwanda in GG at 2303. (Miller, WA) **17715** in GG at 1553. (Jeffery, NY) Radio Africa, **15715** via Germany at 1739 with ID, talks about various problems in Africa, music interludes, frequent use of bird calls. (Montgomery, PA) Info Radio, **7265** at 0057 with news and talks in GG. (D'Angelo, PA)

GHANA—Ghana Broadcasting Corp., **4915** at 2252 with phone numbers for call-in program. (Montgomery, PA)

GREECE—Voice of Greece, **7477** in Greek at 0230 with lots of Greek music. (Quinby, PA) **15630** at 0356 with IS, and ID "This is Athens. You are listening to the Voice of Greece." (Brossell, WI)

GUAM—KTWR/Trans World Radio, **15330** at 1509. (Foss, Philippines) KSDA/Adventist World Radio, **11560** at 1146 with talks in CC. (Brossell, WI)

GUATEMALA—Radio Buenas Nuevas, **4800** at 1100 with religious programming in SS. (Barton, AZ) 0127 with talk by man in SS.

(Jeffery, NY) 0153 with LA music and SS talks, ID and ID at top of the hour. (Wood, TN) 0225 to 0231 sign off. SS anmts, IDs, short music bridges, and off with light instrumental music. (Alexander, PA) 0322. (Brossell, WI) Radio Cultural, **3300** with religious program at 0300. (Paradis, ME)

GUYANA—Voice of Guyana, **3291** at 0840 with local news. (Wilkner, FL)

HAWAII—KWHR, **17510** at 0125 with religious program, ID. (Jeffery, NY) 0343. (Brossell, WI) Armed Forces Network, **6309** at 1520. (Miller, WA) **10320** USB with news and ID "This is AFN News." (Brossell, WI)

HONDURAS—La Voz Evangelica, **4819** in SS with religious music at 0319. (Miller, WA) Radio Misiones Int'l/HRMI, **5010** at 0207 with several SS IDs, SS religious talk, mentions of a U.S. address. (Wood, TN)

ICELAND—AFR Keflavik, **13855** USB heard at 2244 with Rumsfeld interview, PSAs, ID "This is the Armed Forces Network." Followed by AP news and CNN Radio Update at 2330. (D'Angelo, PA)

INDIA—All India Radio, Shillong, **4970** with Sinatra song at 1615. (Foss, Philippines) AIR Kurseong, **4895** with sitar music at 1512. (Foss, Philippines) All India Radio, **9620** at 1930 with drums and vocals. (Barton, AZ) **11620** at 1930 with traditional music. (Paradis, ME) 0233 in presumed Hindi. (Brossell, WI) **15135** Delhi heard at 0240 in Hindi. (D'Angelo, PA)

INDONESIA—Voice of Indonesia, **15150** at 2000 moving from FF to EE with ID, frequencies, program notes, news. (Burrow, WA) 2030 with news. (Linonis, PA) Radio Republik Indonesia, Serui, **4606.4** in II at 1111. (Strawman, IA) RRI—Wamena, **4870** at 1101 in II with pos. (Strawman, IA) RRI-Bukittinggi, **3232** in II with vocals heard at 11547. (Foss, Philippines)

IRAN—VOIRI, **7245/9635** at 1528 with IS, ID, choral anthem, schedule, EE interpretation of Koran, news. (Burrow, WA) On unlisted **11610** in FF at 0230 with ID, Koran, a minute of SS, and off abruptly at 0235. (Brossell, WI)

IRELAND—RTE, 13640 via Canada with soccer match at 1842. (Miller, WA) **15585** via UK at 1809 with local weather, interviews. (DeGennaro, NY)

ISRAEL—Kol Israel, **11585** with US pops at 0224. (Brossell, WI) **15760** at 0020 with interview wife of an American rabbi serving in U.S. Army in Iraq. (Foss, Philippines) **17535** in HH at 1923. (Miller, WA)

ITALY—RAI, **11800** with IS and news at 2234. (Miller, WA)

JORDAN—Radio Jordan, **11810** heard at 2138 with Koran, talks in AA. (Brossell, WI)

JAPAN—Radio Japan/NHK, **6110** (via Canada—gld) at 0505 with news. (Moser, IL) **7200/9750/11705//11730** at 1504 with news, ID. (Burrow, WA) 9750 with news after 1500 time pips. (Barton, AZ) **17825** at 2145 on medical clinics in Japan. (MacKenzie, CA) 0325 with news and tourist info. (Brossell, WI)

KUWAIT—Radio Kuwait, **15495** in AA

Before there was Vietnam there was French Indo China, and before there was Radio Vietnam there was Radio Saigon. This card was issued in 1947! →

We are pleased to verify your reception of

RADIO - SAIGON

(French Indo-China)

Broadcasting on $f = 7.8$ megacycles, i. e. **285 meters**
on the **21st June** 1947 at **14.50 G.M.T.**

Our Wavelengths	Our English daily sessions (G. M. T.)
11.78 mcgs in the 25 m. band	0.45 to 1.00 AM
6.15 mcgs in the 49 m. band	10.00 to 10.45 AM
1.05 mcgs in the 285 m. band	13.30 to 14.30 PM

at 0316. (Jeffery, NY) 0346. (Brossell, WI) **15505** in AA at 1900. (Paradis, ME)

LESOTHO—Radio Lesotho (t) **4800** at 0300 in presumed Swahili with African drums and music. (Linonis, PA)

LIBERIA—Radio Veritas (p) **5470** heard at 0708 but very, very weak. (Alexander, PA)

LIBYA—Radio Jamahiriyah, **15310** in AA with folk music heard at 1940. (Ziegner, MA)

LITHUANIA—Radio Vilnius, **9875** at 2329 with IS and ID but too weak to copy much else. (Burrow, WA)

MADAGASCAR—Radio Netherlands relay, **15560** heard at 0352 with EE news items and comments in DD. (Brossell, WI) **17580** with IS to 1330 and opening in DD. (Barton, AZ) Radio TV Malagasy, **5010** at 0258 with IS, choral anthem, man with opening ID, and anmts at 0303, f/by news in Malagasy. (D'Angelo, PA) Radio Voice of Hope, **12060** at 0427 with EE ID and talk in unid language. Bubble jammer in the background. (Burrow, WA)

MALAYSIA—Radio Malaysia, **5030** at 1448 with woman vocal. (Foss, Philippines) **7295** at 1523 with music dedications from Radio 4 service. (Burrow, WA)

MAURITANIA—Radio Mauritanie, **4845** with Holy Koran in AA heard at 0045. (Linonis, PA) 0655 with prayers. (Wood, TN)

MEXICO—Radio Educacion, **6185** with SS music at 0224 and 0417. (Miller, WA) 0700. (Barton, AZ) Radio Mexico Int'l, **11770** with SS IDD at 1310. (Brossell, WI) XERTA, **4800** in SS at 0115. (Watts, KY)

MONGOLIA—Voice of Mongolia, **12085** at 1000 with ID, local music, Mongolian rock group, interview on relations with India. (Foss, Philippines) 1013 with commentary by woman, music, more talk by woman. Ending program at 1028 with schedule and address, IS played three times and language change at 1030. (Montgomery, PA)

MOROCCO—RTV Marocaine, **7185** in AA at 0211. (Jeffery, NY) **11920** with news in AA at 0413. (Miller, WA) 0456 in AA. Strong but with DW QRM. (Moser, IL) **15345** with instrumental music and AA talk at 1525. (Brossell, WI) 2055 in AA. (DeGennaro, NY)

NETHERLANDS—Radio Netherlands, **15220** via Canada at 1530–1600. (Linonis, PA) 1530. (Paradis, ME)

NETHERLANDS ANTILLES—Radio Netherlands Bonaire Relay **9845** at 0100. (Linonis/Quinby, PA) **21590** on logging in Estonia at 2015. (Barton, AZ)

NEW ZEALAND—Radio New Zealand Int'l, **9885** with news and interviews at 1034. (DeGennaro, NY) News at 1015. Also 11820 at 0600. (Barton, AZ) **11820** at 0530 with NZ troops to restore order in the Solomons. Also **15160** at 2046. (Miller, WA) 15160 with local weather at 2105. Also **17765** with an opera selection at 0116. (Foss, Philippines) 17675 at 0222 with 1930s music program with contest and call-ins, South Pacific news at 0300, "Mailbox" at 0308. (Burrow, WA) 0328 with jazz request program. (Brossell, WI)

NIGERIA—Voice of Nigeria, **7255** with news in Hausa at 2200. (Ziegner, MA) **15120** at 1906 on village life, ID, program notes, time check, news. (Burrow, WA) 2200 with news. (Miller, WA) Radio Nigeria, **3326** at 0430 with unfamiliar IS and announcements. (Paszkiwicz, WI)

NORTH KOREA—Frontline Soldiers Radio, **3025** at 1532 with rousing choral music. (Foss, Philippines) Korean Central Broadcasting Station, **2850** at 1523 with moody vocals. (Foss, Philippines) (Now what could North Koreans possibly have to be moody about?—gld) Voice of Korea, **7580** with choral and march music at 1145. (Barton, AZ) **9335/11710** with EE news at 1504. (Burrow, WA) 11710 heard at 1259 with IS, then "This is the Voice of Korea" by man, then woman and "This is the English transmission from the Voice of Korea from Pyongyang. Now the news." (Brossell, WI)

NORTHERN MARIANAS—KFBS, **11580** in CC at 1148. (Brossell, WI)

NORWAY—Norwegian Radio, **13710** at 0306 and **17505** at 1917 both in NN. (Miller, WA) **15735** in NN at 1207. (Brossell, WI)

OMAN—BBC Relay, **15575** at 0300. (Linonis, PA)

PAKISTAN—Radio Pakistan, **15065** at 1601 with EE news, ID at 1604. (Burrow, WA) **17895** at 0152 in unid language. (Jeffery, NY)

PAPUA NEW GUINEA—Radio Simbu, Kundiawa, **3355** in Pidgin at 1004. (Miller, WA) Radio Western Highlands, Mt. Hagen, **3375** in Pidgin with news at 1007. (Miller, WA) NBC, Port Moresby, **4890** at 0940 in

mostly Pidgin. (Montgomery, PA) In EE at 1256. (Miller, WA) Radio Manus, Lorengau, **3315** in Pidgin at 0955. (Miller, WA) Radio East Sepik, Wewak, **3335** in Pidgin at 0956. (Miller, WA)

PERU—Reina de la Selva, **5486.7** in SS at 1040. (Wilkner, FL) Radio Atlantida, Iquitos, **4790** in SS at 1251. (Miller, WA) Radio San Nicholas (t), **5471.9** at 1105. (Wilkner, FL) Radio Libertad de Junin, **5039** at 1100 with "flauta Andina" and man with ID. (Wilkner, FL) Radio Ilucan, **5678** at 0051 with OA music, ID by man at 0055. (Montgomery, PA) Radiodifusora Huancabamba, **6536** at 0030 with OA folk music, SS talk, ID. (Montgomery, PA) 0212 with OA vocals, but weak and heavy QRN. (Montgomery, PA) Radio Victoria, **6020.3** at 0235 with long SS religious talk before a live audience, ID and anmts at 0330. Slop from REE-6020. (D'Angelo, PA) 0855 with long SS talk, fanfare, short program comments, another fanfare, and canned ID. Reception became nearly impossible with the sign on of Radio Gaucha at 0901. (Montgomery, PA) Radio La Hora, **4856** with OA folk music and SS ID from 0120. Mentions of Cusco. (Alexander, PA) Ondas del Rio Mayo, **6797.5** at 0000 with rustic OA folk music, SS talks, ID, and abruptly off at 0104. (Alexander, PA) Radio Tawantinsuyo, Cusco, **6173.9** monitored at 1045 with ID, rapid SS talks. (Wilkner, FL)

PHILIPPINES—Radio Pilipinas, **15120** at 0225 with report on trade with Korea, music, news at 0230, and ID as "PRA." (Burrow, WA) Radio Veritas Asia, **9540** with long talk by woman in Asian language to 1430 close. (Barton, AZ) VOA Relay, **6110** at 1146 in Mandarin. (Strawman, IA) **9760** with news at 1305. (Brossell, WI) **17765** in CC at 0136. (Jeffery, NY) **17740** at 2150. (MacKenzie, CA)

POLAND—Radio Marya (t) **15445** at 0705 with news by man and woman in vernacular, partial ID monitored at 0710. (Wood, TN)

PORTUGAL—RDP Int'l, **12030** in PP at 0400 with sign on, IS, ID, news. (Linonis, PA) **17575** in PP at 1923. Also noted on **17680**. (Miller, WA) **21810** with ID at 1300. (Foss, Philippines)

PUERTO RICO—Armed Forces Network, **7507** (new) at 2337 with "Sports Byline" program. (D'Angelo, PA) 1020 resetting some morning NPR programs. (Barton, AZ) 0102 with ball game. (Montgomery, PA)

ROMANIA—Radio Romania Int'l, **11940** in FF at 2040. (DeGennaro, NY) 0239 with interview with U.S. ambassador, ID 0242. (Burrow, WA)

RUSSIA—Magadan Radio, **9530** in RR at 2052. (Foss, Philippines) Voice of Russia, **9745** with "Commonwealth Update" at 1824. (Foss, Philippines) **11500** (believed via Tajikistan) at 1550 with cultural program. Also at 0300 with IS, time pips, and news in unid language. (Brossell, WI) (Barton, AZ) **11675** at 1958 with website, IS, "This is Moscow" and abrupt close. (Moser, IL) **11750** with news at 0300. (Barton, AZ) **11825** at 0130 on Russian museums. (Linonis, PA) **12055** at 1952. (Strawman, IA) **15510** in possible Urdu at 1444. (Ziegner, MA)

RWANDA—Deutsche Welle relay, **17860** at 2143 with music program, ID at 2145. (Wood, TN)

SAUDI ARABIA—BSKSA, **9870** in AA at 2100. (Brossell, WI) **15435** in AA to 1800 close. (Miller, WA)

SEYCHELLES—BBC Relay, **15420** with news heard at 0344. (Brossell, WI)

SINGAPORE—Radio Singapore, **6150** at 1533 with EE ads, music, call-ins. (Burrow, WA) **9665** at 1158 in Malayan service. Into Indonesian news at 1200. (Strawman, IA) BBC relay, **9740** at 1105 with news. (DeGennaro, NY) 1300. (Barton, AZ) **11945** in CC at 1156. (Brossell, WI)

SOLOMON ISLANDS—SIBC, **5020** at 0931 with news, ID, PSAs. (D'Angelo, PA) 1115 with news in EE. (Strawman, IA) 1300 with BBC programming. (Miller, WA)

SOUTH AFRICA—Adventist World Radio via Meyerton, **15345** at 0600 with IS, ID, into religious program. (Linonis, PA) Radio Sonder Grense, **3320** at 0302 with news in Afrikaans, pop vocals. (D'Angelo, PA) BBC relay, **7120** at 0420. (Miller, WA) Channel Africa, **11710** with news at 0500. (Moser, IL) **15265** at 1703 with news, ID, program notes, report on war crimes in Sierra Leone. (Burrow, WA) **17770** in FF at 1541. (Brossell, WI) **21760** at 1430. (Paradis, ME)

SOUTH KOREA—Radio Korea Int'l, **9560/15575** at 0207 with news, ID at 0209. (Burrow, WA)

SPAIN—Radio exterior de Espana, **9730** opening in SS at 1159 and mixing with VOA-Philippines. Also **9765** opening at 1200 and QRMed by VOA-**9760**. (Barton, AZ)

SRI LANKA—SLBC (t) **15745** at 0355 with easy listening oldies, mention of Sri Lanka at 0400. (Burrow, WA) VOA Relay, **7115** with news at 0120. (Strawman, IA) **15690** in unid Asian language at 1533. (Brossell, WI) **17855** in unid language at 0316. (Jeffery, NY)

SWITZERLAND—Swiss Radio Int'l, **15220** (via *French Guiana—gld*) at 1950 with beam to Africa. (Moser, IL)

SYRIA—Radio Damascus, **13610** at 2059 with mix of music, domestic news. Transmitter on/off at 2106, ID at 2112. (Burrow, WA)

TAIWAN—Radio Taiwan Int'l, **15265** (direct) in CC at 1318. (Brossell, WI) **15600** via Florida in FF at 2058. (DeGennaro, NY)

TANZANIA—Radio Tanzania (t) **7165** at 0600 with EE talk. Rather weak but peaked at 10 over S9 at times. (Linonis, PA)

THAILAND—Radio Thailand, **15395** at 0300 with time pips, ID, news, schedule, ID again and Thai news. (Burrow, WA) VOA Relay, **15150** in Mandarin at 0152. (Strawman, IA)

TUNISIA—RTT Tunisienne, **12005** in AA at 0437. (Miller, WA) **17735** at 1537 with AA vocals and talk. (Foss, Philippines)

TURKEY—Voice of Turkey, **11655** at 0311 with Turkish economic news, ID, and promo for their 2003 essay contest. (Burrow, WA) **11885** in TT at 0130. (Quinby, PA) 0151. (Miller, WA) 12000 at 2200 with IS, ID, news, and "Outlook" program. (Paradis, ME)

UGANDA—Radio Uganda, **4976** at 0303 but carrier noted at 0230 to top of the hour. Short IS, woman with ID at 0301 then male anncr at 0303 and rooster crow and bird sounds in background as he gave program details. Difficult copy with a het on the frequency. (Montgomery, PA) 0315 in unid language, Afro-pops, and slow speaking anncr. (Linonis, PA)

UKRAINE—Radio Ukraine Int'l, **12040** at 0300 with IS, ID, news. (Burrow, WA)

UNITED ARAB EMIRATES—UAE Radio, Dubai, **13675** at 0330 going from AA into EE with news and ID. (Burrow, WA) **11950** at 0045 in AA. (Quinby, PA) **15395** in AA at 1528. (Brossell, WI) 1803. (DeGennaro, NY) UAE Radio, Abu Dhabi, **17630** at 1529 with IDs in EE and several other languages, Mideast music, and man in unid language. (Foss, Philippines)

UZBEKISTAN—Radio Tashkent, **11905** at 2030 with IS, ID, but very weak. (Burrow, WA) 2130 with news, music, comment. (Paradis, ME) 2140 on the need for a Central Asian accord. (Ziegner, MA)

VATICAN—Vatican Radio, **11625** heard at 0505 in African service. //15575. (Moser, IL)

VIETNAM—Voice of Vietnam, **5925** in VV at 1423. (Foss, Philippines) 12020 in EE at 1002 with news by man and woman anncrs, ID at 1010. (Montgomery, PA)

ZAMBIA—Zambia National Broadcasting Corp., **4910** at 0246 with fish eagle IS to choral anthem at 0250 then man with ID and sign on anmts. Lots of fast talk in something close to EE with drums and **5915** mentioned. High life vocals from 0300. (D'Angelo, PA) 0249 with fish eagle IS, mentions of "Radio Zambia," program anmts in local language. Nothing on former **6265**. (Montgomery, PA) (*Nice to have them back where they "belong"—gld*) 0400 with news about Zambia, drums, flutes, tribal singing, ID. (Paszkievicz, WI)

And that's a wrap for this time! A Mt. Everest-size thank you to the following who did the right thing this month: Bruce Burrow, Snoqualmie, WA; Robert Montgomery, Levittown, PA; Sheryl Paszkievicz, Manitowoc, WI; Rick Barton, Phoenix, AZ; Marty Foss, Guinayangan, Philippines; Mike Miller, Issaquah, WA; Dave Jeffery, Niagara Falls, NY; Rich D'Angelo, Wyomissing, PA; Joe Wood, Gray, TN; Robert Brossell, Pewaukee, WI; Brian Alexander, Mechanicsburg, PA; Robert Wilkner, Florida; Jock Linonis, Hermitage, PA; Cero DeGennaro, Feura Bush, NY; Jerry Strawman, Des Moines, IA; Tricia Ziegner, Westford, MA; Samuel Quinby, Sharon, PA and R.C. Watts, Louisville, KY.

Thanks to each one of you. Until next month, good listening!

Commander Bunny: Army Motor Pool Officer?

This month we've got a lot of your loggings, so let's get right to it! Remember, you can e-mail me your loggings at popularcom@aol.com or send them by mail to *Popular Communications*, 25 Newbridge Road, Hicksville, NY 11801. It doesn't matter if you've only got one pirate logging—send it to us!

WHYP, 6925 with James Brownyard and ID, e-mail address and report on the third annual WHYP Croquet Open from 0110 tune in. (Rich D'Angelo, PA) 0123 with various songs "Someone Jumped Off the Pringles Can" and others. "Good evening WHYP listeners" at 0126. Also at 0202. (Brian Duddy, NY) 0258 with Ravi Brownyard and hellos to DXers, mention of Thanksgiving 2001. (Joe Wood, TN) 0110 with slightly distorted audio. Another time with a retrospective program at 0100. And a third log at 0038 with a reading from Gizmo and songs about drugs. (William T. Hassig, IL)

WBNY, 6950.6 at 0308 with Commander Bunny giving IDs and mentions of the rodent revolution. (D'Angelo, PA) 6950 at 0105 with Commander Bunny and something about checking tire pressure. Also a tentative log at 2345 with country-rock song "Plastic Jesus." (Hassig, IL)

Sunshine Radio, 6925 at 0140 with song "Hungry Eyes" and woman announcer with "Sunshine Radio" ID followed by

"Unchained Melody." (D'Angelo, PA) 0051 with "Stayin' Alive." ID at 0055, and sign off at 0100. Also logged at 0230 with the "Lion King" theme, ID at 0232, "Duke of Earl," ID at 0240, and song "He's My Guy." (Duddy, NY)

Undercover Radio, 6955 USB at 0207 with "This is Undercover Radio broadcasting from the middle of nowhere." E-mail address for reports was given as undercoverradio@mail.com. (Duddy, NY)

Grasscutter Radio, 6950 USB at 1213 with mentions of Eric Clapton and several Stevie Ray Vaughn selections. The DJ was pretty hung up on the word "man" and sometimes had too much echo, which made it difficult to understand what he was saying. He said the transmitter was putting out around 80 watts. Also played several other rock numbers. (John Tomlinson, TX) (*Great, man!*—ET) Tentative Grasscutter Radio on **6925 USB** at 0210 with Led Zepplin, Jimi Hendrix, and song "London Calling." Sometime around 0241 to 0244 he switched antennas, which improved the signal slightly, but it was still distorted. (Hassig, IL) 2323 "Broadcasting from all over the world." Black Sabbath number, somebody broke into his house and took all his drugs, mentioned "broadcasting from beyond" and "broadcasting from the ionosphere," plus other comments, calling for Commander Bunny and mentioning James Brownyard (as "JB"). (Duddy, NY)

WFMQ, 6925 at 0229 with heavy overdubbing and echo effects. Chanted IDs at 0223, 0229, and 0246. Address as PO Box 28413, Providence, RI 02908. Songs included "Midnight at the Oasis" and a Beatles montage. (Wood, TN)

KRMI, 6925 at 0215 with children's songs and stories to 0232 tune out. This was a relay via WHYP. (Hassig, IL)

WRAY, 6950 at 2356. ID as WRAY and "Ray Radio." Songs included something that sounded like "Wipeout" and "I Feel Good" by the hardest working man in show business at 0002. Good signal level, but hampered by QRN and echoes on the VOX. (Wood, TN)

WMPR, 6955 at 0004 with more music variety than usual, ID at 0009 as "W-M-P-R—Micro Power." (Wood, TN)

Skeleton Radio, 13760 at 1115 with man mentioning operating with a skeleton crew and exercising "our right to free speech." Continued with a monologue about listener mail received. They had a very strong signal at first but were eventually drowned out by utility stations and local QRM. (Alan Dixon, *Pop'Comm*)

Indira Radio, 6925 at 0234 with talking in a foreign language. At 0236 they gave a box number only partly copied and mentioned Kalkuta 02908. Mention of "Performances in India and "Hi, we're the Beach Boys," after which they were either lost or signed off. (Duddy, NY)

I've been informed that Dutch pirate **Alfa Lima International** has gone into hiding after Dutch authorities closed down dozens of pirates, and Alfa Lima was beginning to feel they were coming under the gun. They say they will be back in the near future on their regular **15070** frequency, as well as a new spot between 6.2 and 6.3kHz. (Gosh—and we thought everything was legal in the Netherlands!)

And that takes us to the bottom of the tray for this time. Keep those pirate logs coming my way—I can't print 'em if you don't send 'em! ■

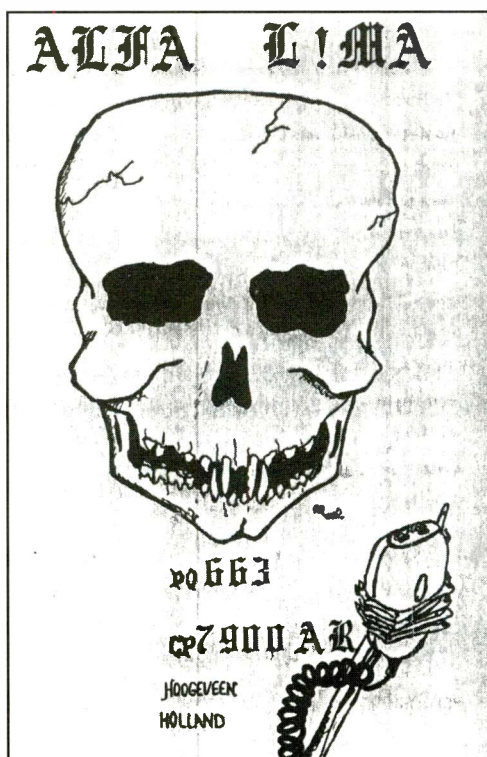

Dutch pirate Alfa Lima International is laying low during a crack down on pirates by the authorities there. They're determined to return, so keep a weekend watch on 15070.

A Look Inside NORAD— The North American Aerospace Defense Command

In 1958, the Americans and the Canadians became partners in protecting the airspace of Alaska, Canada, and the contiguous 48 United States. The mission has evolved over the years. The motto is “Deter, Detect, Defend.”

Until September 11, 2001, NORAD’s focus was virtually exclusively fixed on threats coming toward the Canadian and American borders, primarily from Eastern Asia, not domestic airspace terrorism. Since that day, NORAD’s focus has widened to include American and Canadian domestic airspace. NORAD’s mission is now truly global. Up to the fateful day of September 11, NORAD was a word that was associated with the Cold War, its task to guard against aerospace threats that might come from sources far away from the shores of Canada and the United States.

Today, these skilled men and women of NORAD use ground-based and airborne radar, satellites, fighter aircraft, proven command structures, and intelligence capabilities to enforce control of the skies over the U.S. and Canada.

Agreement

Canada and the United States are more than friends—they’re also allies and partners in defense. Today, there are more than 80 treaty-level defense agreements between the two countries and more than 250 memoranda of understanding between their defense departments. The common defense of the North American continent can trace its history back to 1940 when Canadian Prime Minister Mackenzie King and U.S. President Franklin Roosevelt met to discuss the war in Europe and mutual defense concerns.

In September 1957, both nations agreed to create NORAD, the “North American Air Defense Command,” which was to be headquartered in Colorado Springs, Colorado, as a bi-national command, centralizing operational control of continental air defenses against the then threat of Soviet intercontinental bombers. Eight months later, on May 12, 1958, the agreement between the Canadian and U.S. governments that established NORAD was completed and formalized. The agreement included 11 principles governing the organization and operation of NORAD and called for a renewal of the agreement in 10 years.

The NORAD Agreement has been reviewed, revised, renewed, or extended several times since the first renewal of the agreement in March 1968. It was revisited in May 1973, May 1975, May 1980, March 1981 (when the name was changed to “North American Aerospace Defense Command”), March 1986, April 1991, March 1996, and June 2000.

The renewal of 1996 redefined NORAD’s missions as aerospace warning and aerospace control for North America. The new agreement included a consultative mechanism for issues concerning aerospace defense cooperation and a provision for

the review and management of environmental practices related to NORAD operations. As part of its aerospace control mission, NORAD also assists local civil authorities in the detection and monitoring of aircraft suspected of illegal drug trafficking. The 2000 renewal, which became effective on May 12, 2001, extended the NORAD Agreement for another five years.

One of the strengths of the NORAD Agreement and a testimony to the close cooperation between Canada and the United States is the continuing adaptation of NORAD’s mission and capabilities to meet the challenges posed by ever-changing threats. The events of September 11, 2001, provide evidence of NORAD responsive capabilities and continued relevance to North America.

North Warning System (NWS)

The North Warning System, formerly the DEW (Distant Early Warning) Line, provides surveillance of potential attack routes via the Arctic airspace. The NWS consists of 15 long-range radars (11 in Canada, four in Alaska) and 39 short-range radars (36 in Canada, three in Alaska) along the northern coast of North

NORAD Command Frequencies

Nationwide

148.125 276.4 276.65 279.4 285.9 298.3 364.2 397.25

Alaska Air Defense SOCC

229.1 238.4 240.2 254.5 254.6 261.6 261.7 262.4 264.4 269.9
278.0 287.5 288.4 292.0 293.2 297.6 297.8 315.4 325.0 325.8
397.8

Western Air Defense SOCC

228.6 228.9 234.6 235.9 238.4 239.7 252.0 254.2 260.8 265.4
267.0 270.2 271.0 274.4 277.6 281.6 282.6 288.4 298.1 309.4
316.3 320.6 324.0 327.9 328.0 336.6 341.8 346.2 348.2 351.5
355.2 359.8 374.0 377.0 386.0 387.8 390.2 394.2 397.8 398.0

Northeast Air Defense SOCC

228.7 228.8 229.1 233.6 235.8 239.2 239.4 251.8 258.0 273.4
278.2 278.4 282.5 284.8 292.4 292.8 293.6 297.7 298.8 303.9
309.5 312.8 316.2 318.1 318.4 326.4 327.2 338.8 342.1 347.4
348.8 351.6 357.1 371.0 371.8 376.2 379.0 384.0 389.2 394.8
396.8 399.0

Southeast Air Defense SOCC

228.8 234.7 238.5 251.0 256.6 263.2 270.4 275.0 278.6 292.7
298.5 302.4 306.4 325.5 338.4 344.0 356.0 369.0 375.1 386.2
392.8

Holiday gift ideas

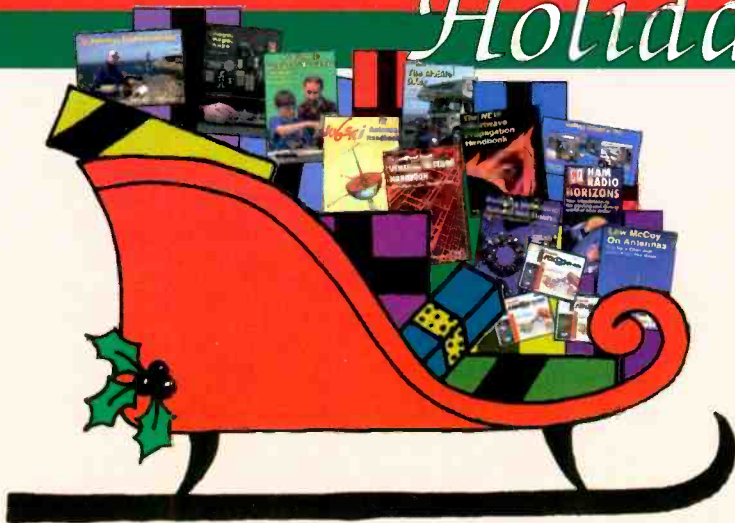

33 Simple Weekend Projects

by Dave Ingram, K4TWJ

Do-it-yourself electronics projects from basic to sophisticated. You'll find: station accessories for VHF FMing, working OSCAR satellites, fun on HF, trying CW, building simple antennas, even a complete working HF station you can build for \$100.

~~\$15.95~~ NOW ONLY \$9.95



The NEW Shortwave Propagation Handbook

by W3ASK, N4XX & K6GKU

A comprehensive source of HF propagation principles, sunspots, ionospheric predictions, with photography, charts and tables galore!

Order No. SWP **\$19.95**

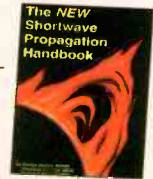

W6SAI HF Antenna Handbook

by Bill Orr, W6SAI

Inexpensive, practical antenna projects that work! Guides you through the building of wire, loop, Yagi and vertical antennas.

Order No. HFANT **\$19.95**

Keys, Keys, Keys

by Dave Ingram, K4TWJ

You'll enjoy nostalgia with this visual celebration of amateur radio's favorite accessory. This book is full of pictures and historical insight. Order No. KEYS

\$9.95



The Vertical Antenna Handbook

by Paul Lee, N6PL

Learn basic theory and practice of the vertical antenna. Discover easy-to-build construction projects

Order No. VAH **\$9.95**

NOW ONLY **\$6.95**



McCoy on Antennas

by Lew McCoy, W1ICP

Unlike many technical publications, Lew presents his invaluable antenna information in a casual, non-intimidating way for anyone!

Order No. MCCOY **\$15.95**

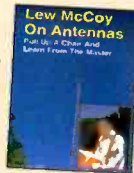

2004/05 calendar

January 2004 through March 2005

ONLY \$10.95

Amateur Radio Calendar

15 spectacular images of some of the biggest, most photogenic shacks, antennas, scenics and personalities. Calendars ship Oct 9th!

Building and Using Baluns and Ununs

by Jerry Sevick, W2FMI

The source for information and designs on transmission line transformer theory. Applications for dipoles, yagis, log periodics, beverages, antenna tuners, and countless other examples. Limited quantities of this "classic" are available.

Order No. BALUN **\$19.95**

NOW ONLY **\$18**

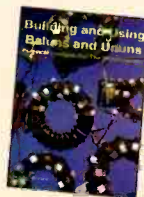

The Mobile DXer

by Dave Mangels, AC6WO

An in-depth look at Mobile DXing includes its language; versatility; selecting and installing mobile HF radios; mobile HF antennas and tuners; tuning HF antennas; utilizing tools, tactics, and techniques; and more!

Order No. DXER **\$12.95**



Hot Item!

Ham Radio Magazine on CD

Brought to you by CQ & ARRL

Here's what you've been waiting for! Enjoy quick and easy access to every issue of this popular magazine, broken down by years!

Three sets, each containing 4 CDs -

1968-1976 Order No. HRCD1 **\$59.95**

1977-1983 Order No. HRCD2 **\$59.95**

1984-1990 Order No. HRCD3 **\$59.95**

Buy All 3 Sets and **Save \$29.90!**
Order No. HRCD Set **\$149.95**

videos

\$19.95
NOW ONLY \$12.95 ea.

Buy all 7 for your Club for only **\$69.95**

Ham Radio Horizons: The Video

..... Order No. VHOR

Getting Started in Packet Radio

..... Order No. VPAC

Getting Started in Ham Radio

..... Order No. VHR

Getting Started in Contesting

..... Order No. VCON

Getting Started in DXing

..... Order No. VDX

Getting Started in VHF

..... Order No. VVHF

Getting Started in Amateur Satellites

..... Order No. VSAT



Visit Our Web Site
www.cq-amateur-radio.com

Name _____ Callsign _____

Street Address _____

City _____ State _____ Zip _____

Qty	Item #	Description	Price	Total Price
Shipping & Handling: U.S. & Possessions - add \$5 for the first item, \$2.50 for the second and \$1 for each additional item. * FREE shipping on orders over \$75.00 (merchandise only). Foreign-Calculated by order weight and destination and added to your credit card charge.			Total	

Method of payment Check Money Order Visa MasterCard Discover American Express

Credit Card No. _____ Expiration date _____



CQ Communications Inc., 25 Newbridge Rd., Hicksville, NY 11801/516-681-2922; Fax 516-681-2926
Order Toll-Free 800-853-9797

NEW/CHANGED/DELETED FREQUENCIES

NEW

AZ

Tucson, Davis-Monthan AFB (DMA)
 Cmd Post (Callsign RAYMOND 8) 381.3
 PMSV METRO 239.8

AL

Montgomery, Maxwell AFB (MXF)
 AFRC 908AW Cmd Post (Callsign TOIL OPS) 396.9
 PTD 122.85, 372.2
 Muscle Shoals, Big River Airpark Airport (5AL5)
 Unicom 122.8

CA

China Lake NAWS (Armitage Field) (NID)
 VFR Advsy Svc 126.55, 127.5, 133.65, 291.6, 348.7
 Los Alamitos AAF (SLI)
 ARCOM Ops 139.05, 230.9
 PMSV METRO 239.8
 Marysville, Beale AFB (BAB)
 940th Cmd Post (Callsign TAHOE CON) 351.2
 Supervisor of Flying 139.9, 240.225
 Mountain View, Moffett Federal AFLD (NUQ)
 ASOS 124.175
 Moffett Rescue 5711kHz USB
 Oceanside, Camp Pendleton MCAS (Munn Field) (NFG)
 ApcH Ctrl 128.45, 281.6
 CD 340.2
 MCB Range Control 123.2
 PMSV METRO 342.4

CO

Fort Carson, Butts AAF (FCS)
 LC 41.5 kHz, 239.3

FL

Cocoa Beach, Patrick AFB (COF)
 Cmd Post (Callsign MAYAAP) 138.3, 383.0
 LC 269.375
 Homestead ARB (HST)
 PMSV METRO 344.6

PTD 372.2
 93FS (Callsign MAKO OPS) 138.02, 303.15
 Key West NAS, Boca Chita Field (NQX)
 PMSV METRO 344.6
 Mayport NAS (Adm David L. McDonald Field) (NRB)
 PMSV METRO 289.95
 Panama City, Tyndall AFB (PAM)
 Cmd Post 381.3
 PMSV METRO 290.625

GA

Marietta, Dobbins Air Reserve Base/Atlanta NAS (MGE)
 ARNG OPS 47.0 FM
 94AW Cmd Post (Callsign DAPPER DAN) 381.3
 NAVY OPS 340.2
 PMSV METRO 274.75
 PTD 372.2
 Warner Robins, Robins AFB (WRB)
 AFRC Cmd Post (Callsign GUNRUNNER) 372.175
 Maint Ctrl Center 225.925

KY

Fort Campbell/Hopkinsville (HOP)
 Eagle Control 139.3, 242.4
 PMSV METRO 343.3
 PTD 122.95, 230.1
 Fort Knox, Goodman AAF (FTK)
 Air to Air 237.5
 PMSV 139.65

ME

Brunswick NAS (NHZ)
 ATIS 120.55

MN

Minnesota, Camp Ripley, Ray S Miller AAF (RYM)
 MLS 111.1

MS

Meridian NAS/McCain Field (NMM)
 CD 301.0
 BasOps 352.2

America. The state-of-the-art radars form a 2,980-mile-long, 199-mile-wide "tripwire" stretching from Alaska to Newfoundland.

Cheyenne Mountain Operations Center

Cheyenne Mountain Air Force Station (CMAFS) is commonly referred to as the Cheyenne Mountain Operations Center. CMOC contains elements from North American Aerospace Defense Command, U.S. Strategic Command (formerly Strategic Air Command), and Air Force Space Command.

Several operational centers make up the CMOC: Command Center, Air Warning Center, Missile Warning Center, Space Control Center, Combined Intelligence Watch, Weather Support Unit, and Systems Center. In 1956, the idea of a hardened command and control center was conceptualized as a defense against Soviet bombers. After the Soviet launch of Sputnik in 1957, the concept of CMOC focused more on early warning and the ballistic missile threat.

Cheyenne Mountain was selected based on three key criteria: geographically centered in North America, area of low seismic activity, and already established military presence in Colorado Springs. Excavation and construction for the complex began in June 1961 and took 55 months to complete. The Cheyenne Mountain Complex became completely operational April 20, 1966. The Army Corps of Engineers supervised the excavation and construction. They used 1.5 million pounds of dynamite to excavate approximately 1 billion, 400 million pounds of granite.

In the 1960s the project was completed at a cost of \$142 million. The GAO report released in the 1990s stated that duplicating this facility today, with all of its missions, would cost more than \$18 billion.

The actual operations complex is a series of 15 buildings, 12 of which are three stories tall. Each building has its own tunnel system and can function independently of the other structures. The entire operations complex is mounted on 1,319

NM Clovis, Cannon AFB (CVS) Cmd Post	11175kHz	VA Hampton, Langley AFB (LFI) PTD	was 376.0, now 376.2
OH Akron-Canton Regional (CAK) ARNG Ops	41.1 FM, 138.55, 227.4	DELETED	
Coshocton, Richard Downing (I40) AWOS-3	118.875	CA Cloverdale Municipal (O60) NORCAL Apch	125.85, 323.0
OK Enid, Vance AFB (END) PTD	372.2	Oceanside, Camp Pendleton MCAS (Munn Field) (NFG) LC	340.2
PA Willow Grove NAS (NXX) AR	34.55 FM, 143.02, 226.5	Sacramento (NCT) NORCAL TRACON	125.85, 323.0
ANG Ops	343.0	OH Akron, Canton Regional (CAK) NG Ops	46.75 FM
VA Fort Belvoir, Davison AAF (DAA) Potomac TRACON	343.7	TX Del Rio, Laughlin AFB (DLF) Apch	363.8
Fort Eustis, Felker AAF (FAF) Basops	134.1	VA Fort Eustis, Felker AAF (FAF) PMSV	118.325
PMSV METRO	134.1, 239.8	Newport News, Williamsburg Intl Airport (PHF) Norfolk Apch	335.625, 379.1
Hampton, Langley AFB (LFI) Apch	125.7, 370.925	Norfolk Intl Airport (ORF) Apch Ctrl	273.475
Cmd Post (Callsign RAYMOND 16)	251.25, 311.0	Norfolk NAS (NGU) Norfolk Apch	125.7
NASA Opns	123.375, 310.4		
WY Dubois Municipal Airport (U25) AWOS-3	118.275		
CHANGED		NEW/CHANGED/CLOSED AIRPORT IDs	
AL Montgomery, Maxwell AFB (MXF) PMSV	was 342.5, now 342.3	NEW	
KY Louisville International, Standiford Field (SDF) LC	was 257.8, now 233.7	AL Muscle Shoals, Big River Airpark Airport	5AL5
OH Columbus, Rickenbacker Intl (LCK) ARNG OPS	was 40.9, 240.9, now 36.7 FM, 142.6, 228.8	MA Beverly, Idlewide Heliport	35MA
		CLOSED/DELETED	
		AZ Quartzsite, Quail Mesa Airport	15AZ

springs, each weighing one half ton. They allow the complex to sway up to 12 inches horizontally in any direction. This ensures the complex's stability in event of an earthquake or nuclear explosion.

The complex operates on a three-stage power system. The primary source is commercial, the secondary is a series of six 2,800-horsepower Enterprise (in-line eight) diesel engines, and the final is a series of approximately 3,500 interconnected batteries, which is referred to as the uninterruptible power system, or UPS, such as is used with many computer systems.

The Cheyenne Mountain complex is about 7,100 feet above sea level at its highest point; Cheyenne Mountain itself is approximately 9,565 feet. There are 110,000 rock bolts that reinforce the tunnel structure. They are from six to 32 feet in length and function like molly bolts, which give the mountain the illusion that there is someone inside pushing outward on the walls preventing implosion or cave-in.

Cheyenne Mountain has four water reservoirs with a six-mil-

lion-gallon capacity. The primary water supply is from a natural spring that supplies from 30 to 120 thousand gallons per day; the complex uses 10 to 15 thousand gallons per day.

There are three blast doors. The two main doors weigh 25 tons, and are manufactured from 3 1/2-foot-thick baffled steel. It takes about 30 seconds to close the doors automatically. Should the automatic mechanism fail, two people can push the door closed and pump lock-bolts into place in about five minutes.

Monitoring NORAD

In our changed world you never know what might happen, so I've provided a comprehensive NORAD frequency list to help you listen in on the action yourself. Remember, though, these frequencies won't always be active when you first tune in, so be patient and let me know what you hear. ■

utility communications

digest

by Steve Douglass
webbfeat@1s.net

news, information, and events in the
utility radio service between 30 kHz and 30 MHz

Homeland Insecurity

Many monitoring enthusiasts have reported that new U.S. homeland security policies have made "on scene" monitoring (such as near military bases and airports) difficult at best and hazardous at worst. Security concerns since 9/11 are understandable, especially near large airports in light of recent arrests involving terrorists trying to obtain Stinger-type missiles.

In my city there is a special spot at the end of a runway at the local airport where aircraft enthusiasts and monitoring hobbyists gather to watch aircraft come and go. It's a great spot on public land where aircraft on approaches and take-offs fly just dozens of feet over an observer's head. I have taken many, many photographs of every type of military aircraft from B-52s to B-2 bombers there and would like to continue to do so. Plus it's a great place to scan the bands and watch the activity at the same time.

Now called Rick Husband International Airport, formerly Amarillo International, the airport is heavily used by the military for training because of its extra long runways. Runway Two-Two is over 13,000 feet long and was part of the now closed Amarillo Air Force Base, a former SAC base and once home to B-52 and B-47 heavy bombers. When the base closed, the runways and facilities were given to the city under the condition that the military could continue to use them, and they still do.

On any given day you'll see many F-16s from Cannon AFB or C-17s from Altus doing practice landings and take-offs. And, with a new Bell Helicopter Textron plant on the south side of the airport building MV-22s, occasionally one can catch the Ospreys on test flights.

However, in light of the new era in terrorism, security at the local airport has been more than beefed up. Security patrols on the perimeter are constant and the days of sitting in a vehicle watching the aircraft unnoticed are long gone. Sit at "the spot" for longer than five minutes and the airport police are bound to notice you. Sometimes the local police are dispatched to find out who you are and to discourage you from parking anywhere near the airport.

I'm not alone in experiencing this. Many monitors all over the world have reported or complained about being run off by security police. Some have even been detained and questioned. For some reason, a car bristling with antennas and occupied by guys watching the aircraft is considered suspicious. Go figure!

In response to this, I have two equal but opposite reactions. First of all, as a member of the flying public I feel more secure knowing that the security police are doing their best to keep the airport secure. On the other hand, in reality I know that if terrorists were to pick a spot near an airport from which to fire a



To get a photo like this, you've got to get close, but hanging around military bases and airports could get you noticed by the authorities. Planning ahead will keep you out of trouble. This C-17 USAF transport from Altus AFB, Oklahoma, was captured while it was practicing landings and take-offs at Rick Husband International Airport.

(Photos by Steve Douglass)

hand-held missile from, chances are no one would ever see them because of the vast acres of real estate under the flight path of an airliner. It's doubtful they would pick a spot anywhere near where an airport security patrol could spot them.

Since airport security patrols don't normally leave the immediate vicinity of the airport in search of possible threats, they do what they can and, unfortunately, that means anyone who parks within or near their security zone becomes a subject of close scrutiny. Because of this, it's become very hard for those of us who enjoy aircraft, military, and utility monitoring to do any on-scene monitoring without being the subject of intense scrutiny, or sometimes even the subject on an FBI investigation.

However, there is a workable solution to this problem and it is in the monitoring enthusiast's own hands. It is only human nature to be fearful of those we know nothing about, so what we need to do is make ourselves *known*.

On one of my visits to the spot, I decided that when I was approached by airport security, I wouldn't leave (like other radio-monitors did when they heard the patrol cars being dispatched via their scanners). Instead, I would cautiously approach them and make myself known.

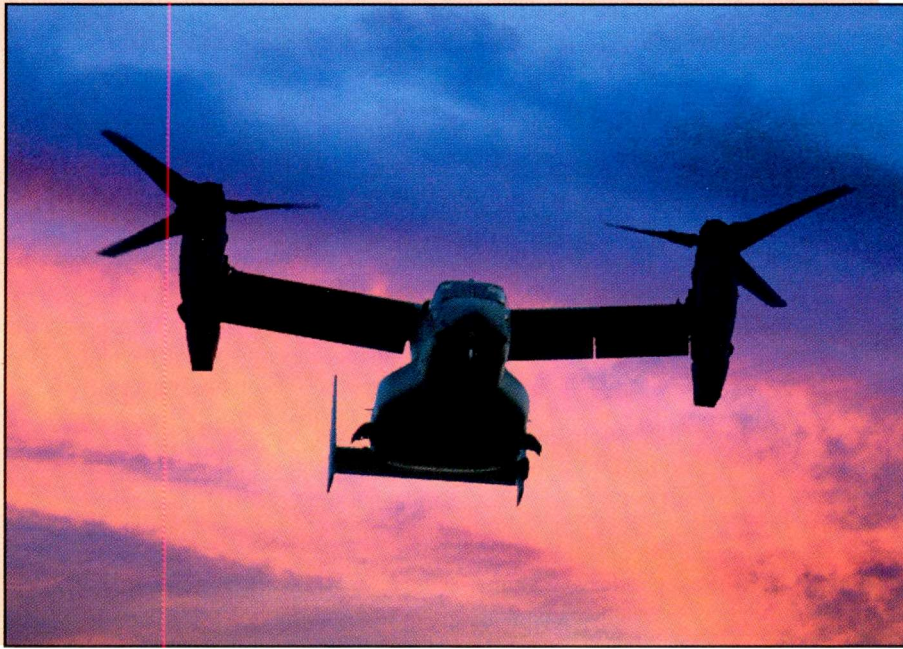

I shot this MV-22 Osprey while it was on a test flight flying back to the Amarillo Bell-Textron V-22 plant. I couldn't have taken this shot without developing a good relationship with airport security.

After parking at the spot for 10 minutes, I soon monitored two-units being sent out to find out who I was. I'm sure when they pulled up they were surprised to find me standing at the perimeter fence, smiling and signaling them to come over. Usually they sit and watch any suspect vehicle and then call local police to investigate. But I guess that because I was out of my vehicle, smiling and not carrying anything, they decided it was safe enough to come over to see what I wanted.

They approached cautiously with their hands on their gun-holsters, but not in an overly threatening manner. When they got to the fence I put out my hand to offer a friendly handshake and said, "Hello, my name is Steve Douglass. I'm an aircraft enthusiast and radio hobbyist who just loves to photograph military aircraft. Is it all right if I stay at this spot for awhile and watch the aircraft come and go?"

Instantly they relaxed. "Would you like to see some identification?" I offered. They answered "Yes." I could tell from the instant change in their demeanor they were pleased to see such openness. My guess was that they were used to people being evasive. I gave them my license. One of them went back to his car to radio the local police for any information they might have on me in their database.

I chatted with the other officer for five minutes while we waited for the result of

their inquiry. I tried to assure him that I was just interested in watching the planes and was not a threat. I also said I would like to visit the spot often and I hoped they would allow me to do so. I also said that I understood the difficult position they were in and appreciated what they were doing. As it turned out, he was an aviation buff, too, and he talked about all the cool military planes he had seen at the airport, including some F-117s that came and went in the middle of the night.

My record came back clean and they seemed satisfied to find out I wasn't a nut or a terrorist. We chatted for about 10 more minutes about military aircraft, radios, and the like. Soon it was clear to them I was just an aircraft buff.

Since then I have visited the spot many times without raising the eyebrows of security. Sometimes they stop to chat about recent events at the airport and I have begun to know them as just normal work-a-day Joes doing a difficult job. I went so far as to tell them that if I ever saw anything suspicious I would be sure to call them. That they appreciated very much.

As a gesture of my appreciation I printed some of my favorite photos and sent them to the security office with a card of thanks. Now whenever they stop and talk they show me their photos!

As a result I've reclaimed my spot and can again come and go as I please with-

out fear of being harassed by the airport or local police. I suggest to anyone in my position to do the same as I did when approached by any of these hard-working officers.

Here are 10 simple guidelines to follow:

1. When approached, make yourself known and don't run off.
2. Don't ever trespass on government or airport property.
3. Never carry a weapon on yourself or in your vehicle.
4. Be sure to show you are unarmed and not make any sudden or overt moves towards the officers.
5. Be friendly, but not overly so. Be calm and do everything in slow motion.
6. Ask them for a phone number where you can call them to let them know in advance that you'll be in the area or so you can report suspicious behavior.
7. Take time to learn their names. Only strangers are suspect.
8. Don't complain or gripe about "your right to be there."
9. Obey all warning signs and, in particular, NO TRESPASSING and NO PHOTOGRAPHY signs. Always ask permission to photograph.
10. Agree to any background check or personal search. If you have a criminal record I wouldn't hang around the airport. If you feel that is a violation of your rights, then don't be in their area of security!

Now keep in mind these guidelines only work around civilian-controlled airports. Military bases are a different animal altogether. Since military security officers are not bound by the same rules as civilian agencies you must approach them (if at all) with extreme caution. I suggest that if you want to monitor or photograph near the perimeter of a military base you first make contact by telephone or letter to the base commander, informing him of your intentions and be willing to meet with the appropriate people about any security concerns. Those warning signs that read "Use Of Deadly Force Authorized" mean exactly what they say. So if you get shot while trying to take covert photos of nuclear submarines while trespassing on Navy property, it's your own fault!

Thor's Hammer

There's a unique military monitoring opportunity coming up in February. The

All Reading And No TV Makes Jack A Dull Boy

U.S. Strategic Command and the super-secret National Reconnaissance Office will be conducting a joint strategic exercise called "Thor's Hammer," a name that's significance is not lost on X-File fans. The "strategic game" will play out a crisis incident not unlike the events that occurred on 9/11. It's not known how this game will effect HF military communications, but chances are military monitors will be able to log some rare catches.

Thor's Hammer is designed to address a whole host of security issues, encompassing a wide range of agencies not limited to those involved with homeland security. Missile defense systems, space communications systems, and intelligence gathering systems, as well as government and civil systems will also be tested. The exercise will end when the gamers resolve the faux-crisis, or the scenario leads to a pretend war.

The best frequencies to listen for Thor's Hammer activity will be the Global HF system, as well as VHF/UHF military aviation and SATCOM frequencies. Another best bet to hear the action is to keep an ear to FEMA frequencies.

Down-Time Monitoring Inspiration

When the weather isn't up to par and the airwaves are relatively silent, time to take a break and enjoy other forms of entertainment. Some of us like to watch films. Others are readers. I do both.

If you're anything like me, your bookshelves are crammed to overflowing with technical journals, radio manuals, and books about radio monitoring. I don't want to step on any author's toes when I say this, but most of the books on monitoring have the tendency to be a bit dry in the narrative and about as exciting to read as stereo instructions. Not that they aren't informative and very helpful to monitors, it's just that if that's all you're reading, you are a very dull person indeed.

So the next time you are talking with non-monitoring friends and you can't follow the conversation if it has nothing to do with Ohm's Law, then I suggest you read on. May I make some reading suggestions? The following books aren't about radio monitoring in any strict sense, but are in some small way related to this fantastic hobby we all share. It's a mixed bag, and some of these picks may not be your cup of tea, but all are worth checking out.

So if you can't bring yourself to twiddle the knobs, these books will inspire you to get back to the monitoring post.

Body of Secrets, by James Bamford: An amazing look inside the super-secret National Security Office. You will truly be stunned by what goes on within the NSA. Read about the professional NSA monitors and learn the difference between SIGINT and COMINT.

The Puzzle Palace, by James Bamford: The prequel to *Body of Secrets*. A must read.

The B-2 Story, by Bill Scott: Inside look at the designing and building of the Northrop's B-2 Stealth bomber.

Skunk Works, by Ben R. Rich & Leo Janos: A fascinating look at the inner workings of the legendary "Skunk Works" the geniuses who invented stealth.

The Camera Never Blinks, by Dan Rather: Adventures of a TV journalist, from witnessing the Kennedy assassination to becoming a national TV anchor. (Out of print but you can find this at your local library.)

Dreamland, by Phil Patton: Travels inside the secret world of Roswell and Area 51. I'm not just recommending this book because Phil is a close friend and I'm in it. It's a truly mesmerizing book.

Lockheed's SR-71 "Blackbird" Family, by James Goodall and Jay Miller: Everything you wanted to know about the amazing SR-71, A-12, F-12, M-21, and D-21 but were afraid to ask. Filled with never-before-seen, recently declassified photos of the world's fastest spy plane and family.

Secrets of a Super Hacker, by the Knightmare: Although now a bit dated, this inside look into the tricks hackers use is very eye opening. A must read for anyone interested in computer security.

The Right Stuff, by Tom Wolfe: Sure, you've seen the wonderful movie, but it doesn't compare to how delightful a read the book is. For example, do you know why all pilots wear the same watch and talk like Chuck Yeager?

Rocket Boys, A Memoir, by Homer Hickam: Made into the movie *October Sky*, a wonderful film which doesn't do the book justice.

Lost Moon, The Perilous Voyage of Apollo 13, by Jim Lovel and Jeffery Kluger: The real story behind Apollo 13. See the movie then read this gripping and sometimes frightening book.

Just when you began to think this columnist is an egghead, here's a list of videos that every UTE monitor should have on their shelves. Some are blockbusters and some you may have never heard of. All are must-see TV.

Thirteen Days, starring Kevin Costner: An intense and gripping film about the Cuban missile crisis. I love the U-2 scenes and the photo recon missions over Fidel's missile farms.

Contact, starring Jody Foster: Just goes to show that if you listen to the airwaves long enough you might hear aliens sending us the plans for an inter-dimensional transport.

The Perfect Storm, starring George Clooney: Many of us thrill at monitoring the Coast Guard as they go about their duty of rescuing those in distress on the sea. This movie is the harrowing account of a fishing vessel lost and caught between two powerful ocean storms.

Spygame, starring Robert Redford: Great spy thriller and a compelling look at inside the CIA. I want my monitoring shack to look just like the Crisis Center in this movie!

Signs, starring Mel Gibson: Just goes to show that if you listen to the baby monitors long enough you might hear aliens preparing to invade. Although this movie is supposedly about an alien invasion, it really is not.

Midway, starring Charlton Heston: Excellent example of how communications intelligence can turn the tide of a war.

Saving Private Ryan, starring Tom Hanks: An intense and unblinking look at war. Not for the squeamish. Check out the vintage walkie-talkies in this flick. Although my GMRS probably works better, I want one!

Dr. Strangelove, starring Peter Sellers: I find this movie is a cult favorite of many military monitors, who can recite quotes from it from memory. Dark comedy about the Cold War.

Strategic Air Command, starring Jimmy Stewart: Excellent look back in time to when SAC ruled the skies. Beautiful aerial photography captures the early days of the B-47 and B-52 strategic bombers.

The Bourne Identity: Super cool spy-thriller based on a book by Robert Ludlum. Finally a film that has up-to-date

computer-controlled radio interception equipment in it!

Ice Station Zebra, starring Rock Hudson: Cold war thriller. Cool opening sequence showing the space surveillance systems of the day.

Black Hawk Down, starring Josh Hartnet: Modern tale of a military operation gone completely wrong in Mogadishu, Somalia. Not for the squeamish.

The Sum of All Fears, starring Ben Affleck: Cautionary tale about nuclear terrorism. Truly frightening. I'm very afraid that some day we will look back at this film and say "they said it would happen."

Das Boot, starring Jurgen Prochow: Must-see movie about the hardships of being a German submariner during World War II.

U-571, starring Matthew McConaghey: The race to capture an ENIGMA code machine onboard a crippled German Submarine during WW II.

Crimson Tide, starring Denzel Washington: Power struggle onboard a nuclear submarine. Pays close attention to getting the VLF EAMS right!

Windtalkers, starring Nicholas Cage: Set in the South Pacific during WW II, the film profiles the courage of the Navajo code-talkers.

We Were Soldiers, starring Mel Gibson: Finally a Vietnam War movie that gets it right. Check out the scene where they tune into sporadic-E skip on their military radios during training. I've done that! Warning: not for the squeamish.

Sneakers, starring Robert Redford: Ever thought it would be cool to be paid to snoop? This movie is one of my favorites. On DVD freeze the frames and drool over all the eavesdropping equipment in this movie. I want!

Air Force One, starring Harrison Ford: Closest most of us will get to seeing the communications gear used by "W." This is a taut military aviation thriller! Turn up the surround sound on this one and annoy your neighbors.

Reader's Logs

Not many logs to report this month. Most of us must be reading or watching videos? The pickings were slim, but what there is, is choice:

0000: STATION, Anytown, USA, summary of traffic heard in MODE at 0000 Z. (monitor)

4149: Vessel Commander calling

Jacksonville (WPE) at 0415 in USB. (RW)

6912: UNID YL/EE repeating "SYN2," then off suddenly. USB from 2349-2353Z. (CG)

8414.5: MRCC Cape Town: 1856 GMDSS100/170 test xmsn. (JUM)

8971: FIGHTING TIGER 720 (P-3 NAS Brunswick) wkg u/i stn. Both parties having a hard time hearing each other. 1934 in USB. (RK)

9183: UNID CW. Sounded like a "callup" with "272" sent many times. Then into 5-figure groups with cut zero. Very weak. 2100-2112Z. (CG)

12532.0: PRC Military 0646 4+4 modem/LSB. Other 4+4 on 12458.0, 10272.0, and 10630.0. (JUM)

11565: UNID YL/EE with letters, no apparent grouping. Heard "end of message, new message, 286-286 text," so apparently more than one message sent. Off abruptly. AM heard from 2337-2356Z. (CG)

11.175: SPAR 35 (C-130) wkg Andrews w/ pp AUTOVON 4656, spoke w/ MSGT Grayson re vibration in #2 engine. 1830 in USB. (RK)

11.175: LAZAR 22 (B-52) wkg Carswell Ops via Offutt re landing time. 1434 in USB. (RK)

12581.5: XSV: Tianjin Radio 0648 Sitor-A 100/170 free idle. (JUM)

12590.0: JNA: Japanese MSA 0650 Sitor-A 100/170. 14 pips and free idle. (JUM)

12607.5: UFL: FESCO Vladivostok 0644 Sitor-A 100/170 wkg UIFV: MV Amderma. (JUM)

12637.5: XSG: Shanghai Radio 0655 Sitor-B 100/170 4F. Then Sitor-A free idle. (JUM)

12856.0: XSG: Shanghai Radio 0713 nav warnings. (JUM)

13101.0: WLO: ShipCom LLC Mobile 0715 USB wx and tfc list. (JUM)

16814.5: UDB2: Kholmsk Radio 0410 Sitor-A 100/170 free idle. (JUM)

16819.5: NMN: USCG CAMSLANT 0415 Sitor-A 100/170 free idle. (JUM)

16821.0: VRX: Hong Kong Radio 0421 Sitor-A 100/170 weak. (JUM)

16836.0: UFL: FESCO Vladivostok 0423 Sitor-A 100/170 free idle. (JUM)

18380.2: French Forces Paris (?) 0445 Arq-E3 100/400 weak. (JUM)

18560.0: BMF: Taipei Meteo 0453 FAX 120/576. (JUM)

18714.0: Russian Military MS5. (JUM)

18890.0: P5O: Indonesian Navy Belawan 0405 CW call tape. (JUM)

22461.0: FUJ: French Navy Noumea Baudot 75/850 test tape. (JUM)

This month's UTE log contributors are Chris Gay (CG), Rich Klingman (RK), and Japan UTE Monitor: JUM. Thanks to all for your submissions. Each and every one of your contributions is appreciated.

A Final Word

I want to hear from you—and not just *hear* from you. If you have pictures of your monitoring post and a few words to say about UTE monitoring, send them in to me at the above e-mail address. UTE monitoring hobbyists are an intelligence gathering force of their own with untold years of experience and success at plucking weak-static-filled communications of the ether. I want to hear about your best catch or an experience you had because of what you intercepted. I want to hear about your radio engineering solutions and the unique way you solved an equipment problem or need. After all, this is your forum. Don't be shy. Write today! ■

Mobile DXer by Dave Mangels, AC6WO

A practical guide to Mobile DXing - an exciting, challenging and rewarding facet of today's Amateur Radio!

Here's a sampling of what you'll find inside:

- ✓ Lightning Preparedness
- ✓ Tuning mobile HF Antennas
- ✓ Propagation & Mobile DXing
- ✓ Mobile HF Antennas & Tuners
- ✓ The Language of Mobile DXing
- ✓ The Versatility of Mobile DXing... and more!

Only \$12.95
Plus \$2 shipping & handling

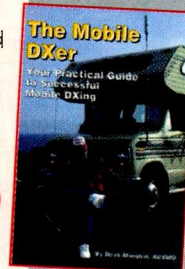

CQ Communications, Inc. 25 Newbridge Road, Hicksville, NY 11801
Phone 1-800-853-9797 • Fax 516-681-2926 • Shop on line at www.cq-amateur-radio.com

U.S.-Canada Spectrum Sharing

The FCC and Industry Canada have signed an Interim Arrangement to facilitate deployment of Wireless Communication systems near the U.S.-Canada border, bringing a broad range of fixed, mobile, and other terrestrial wireless services such as video distribution, programming, digital broadband, and Internet services to businesses and consumers. The agreement details spectrum sharing by licensees in the 2305- to 2320-MHz and 2345- to 2360-MHz bands near the U.S.-Canada border. This latest agreement is part of a series of arrangements between the United States and Canada stemming from a 1962 foundation agreement regarding non-broadcast services. You can read more at www.fcc.gov/ib/sand/agree.

handheld computers, and wireless messaging devices, have on aircraft equipment. If the results of the study indicate that transmissions from these devices do not cause interference, you could soon be dialing from 37,000 feet. The study is expected to be completed by 2005.

Spectrum Enforcement Division

The FCC has announced that it has changed the name of its Technical and Public Safety Division to the Spectrum Enforcement Division. The renamed division will continue to carry out its existing functions, which include enforcement (and support for enforcement by the Bureau's Field Offices) in areas such as unauthorized construction and operation, interference, equipment requirements, 911 and E-911, and radio tower lighting. The Division's responsibilities also include the provision of engineering technology support to the Bureau's Field Offices and the operation of the Bureau's high-frequency direction-finding facilities.

California Cell Phone Ban Overturned

The California State Senate Transportation Committee voted 7-4 to overturn legislation that would have banned the use of handheld cell phones while driving a car. The bill's author, Assemblyman Joe Simitian (D-Palo Alto), did an odd turnaround, urging committee members to oppose his bill because amendments had been attached that would have made it impossible to enforce the legislation.

California Bill To Protect Amateur Radio Broadcasts

California Governor Gray Davis has signed legislation ensuring that amateur radio stations' communications will not be obstructed by any city or county ordinance. Due to the large number of volunteers who use their amateur radio licenses during times of natural disasters or emergency situations, maintaining amateur radio stations' ability to broadcast is an important resource to security and rescue aid. "Licensed amateur radio operators give thousands of hours of volunteer service to the state and local governments," Gov. Davis said. "They are an important part of our public safety network." AB 1228, introduced by Assembly member Bob Dutton (R-Rancho Cucamonga) mandates that city or county ordinances that regulate amateur radio station antennas do not obstruct the communication abilities of the station. It also allows the antenna structures of the radio stations to be constructed to effectively maintain their broadcast services, therefore, preserving the integrity of the radio communications system.

FAA To Study Cell Phones Aboard Airlines

The Radio Technical Commission for Aeronautics (RTCA), a non-profit advisory panel to the FAA, will be conducting a study over the next three years that could result in the approval of cell phone use on board commercial airlines. The group, which consists of representatives from airlines, airplane makers, and the electronics industry, is studying the effects that portable electronic devices, such as modem-equipped laptops,

NY Reallocation Of TV Channel 16

The FCC has responded to a 2002 request by the City of New York to reallocate TV Channel 16 (482 to 488 MHz). The NYPD, on behalf of itself and the other public safety agencies of the New York Metropolitan Advisory Committee (NYMAC), states that there is a need to reallocate TV broadcast Channel 16 in the New York City Metropolitan Area to the land mobile service for public safety communications on a permanent basis. The Commission has granted the Petition and is soliciting comments on various aspects of the technical implementation of the proposal. Interested parties may comment electronically at www.fcc.gov/e-file/ecfs.html, or via U.S. Mail to 445 12th Street, SW, Washington, D.C. 20554. ■

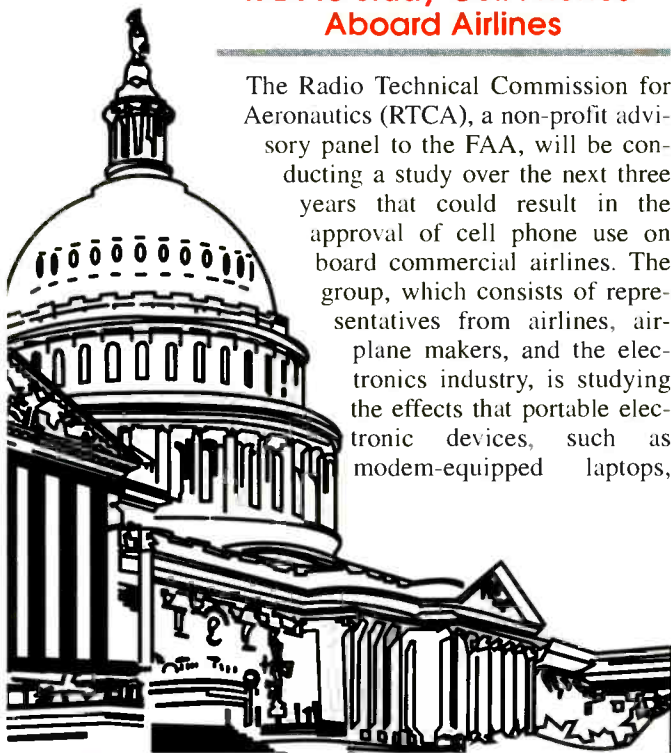

RSGB Books now available from



Antenna Topics

by Pat Hawker, G3VA

RSGB, 2002 Ed. 384 pages. This book is a chronological collection of selections of G3VA's words over the years. Hundreds of areas and subjects are covered and many a good idea is included.

Order No. RSAT **\$29.00**

Antenna Toolkit 2

By Joe Carr, K4IPV

RSGB & Newnes, 2002 Ed. 256 pages. A definitive design guide for sending and receiving radio signals. Together with the powerful suite of CD software included with this book, the reader will have a complete solution for constructing or using an antenna; everything but the actual hardware!



Order: RSANTKIT2 **\$40.00**

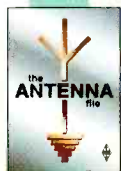

The Antenna File

RSGB, ©2001, 288 pages. \$34.95.

Order: RSTAF

50 HF antennas, 14 VHF/UHF/SHF antennas, 3 receiving antennas, 6 articles on masts and supports, 9 articles on tuning and measuring, 4 on antenna construction, 5 on design and theory, and 9 Peter Hart antenna reviews. Every band from 73kHz to 2.3GHz!

Order: RSTAF **\$32.00**

Amateur Radio

Mobile Handbook

RSGB, 2002 Ed., 128 pages. The Amateur Radio Mobile Handbook covers all aspects of this popular part of the hobby. It includes operating techniques, installing equipment in a vehicle and antennas, as well as maritime and even bicycle mobile. This is essential reading if you want to get the most out of your mobile station.



Order: RSARMH **\$21.00**



HF Antenna Collection

RSGB, 1st Ed., 1992. 233 pages.

A collection of outstanding articles and short pieces which were published in Radio Communication magazine during the period 1968-89. Includes ingenious designs for single element, beam and miniature antennas, as well providing comprehensive information about feeders, tuners, baluns, testing, modeling, and how to erect your antenna safely.

Order: RSHFAC **\$16.00**

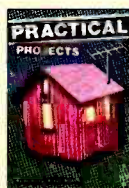

Practical Projects

Edited by Dr. George Brown, M5ACN

RSGB 2002 Ed, 224 pages. Packed with around 50 "weekend projects." Practical Projects is a book of simple construction projects for the radio amateur and others interested in electronics. Features a wide variety of radio ideas plus other simple electronic designs and a handy "now that I've built it, what do I do with it?" section.

Excellent for newcomers or anyone just looking for interesting projects to build.

Order: RSPP **\$19.00**



The Antenna Experimenter's Guide

RSGB, 2nd Ed, 1996. 160 pages.

Takes the guesswork out of adjusting any antenna, home-made or commercial, and makes sure that it's working with maximum efficiency. Describes

RF measuring equipment and its use, constructing your own antenna test range, computer modeling antennas. An invaluable companion for all those who wish to get the best results from antennas!

Order: RSTAEG **\$28.00**

Backyard Antennas

RSGB, 1st Ed., 2000, 208 pages.

Whether you have a house, bungalow or apartment, Backyard Antennas will help you find the solution to radiating a good signal on your favorite band.



Order: RSBYA **\$30.00**

IOTA Directory - 11th Edition



Edited by Roger Balister, G3KMA.

RSGB, 2002 Ed., 128 pages

This book is an essential guide to participating in the IOTA (Islands on the Air) program. It contains everything a newcomer needs to know to enjoy collecting or operating from islands for this popular worldwide program.

Order: RSIOTA **\$15.00**

Low Power Scrapbook

RSGB, ©2001, 320 pages.

Choose from dozens of simple transmitter and receiver projects for the HF bands and 6m, including the tiny OneR transmitter and the White Rose Receiver. Ideal for the experimenter or someone who likes the fun of building and operating their own radio equipment.



Order: RSLPS **\$19.00**



HF Amateur Radio

RSGB, 2002 Ed.

The HF or short wave bands are one of the most interesting areas of amateur radio. This book takes the reader through setting up an efficient amateur radio station, which equipment to choose, installation, and the best antenna for your location and MUCH more.

Order: RSHFAR **\$21.00**

Radio Communication Handbook



Edited by Dick Biddulph, G8DPS

and Chris Lorek, G4HCL.

RSGB, 7th Ed., 2000, 820 pages.

This book is an invaluable reference for radio amateurs everywhere. It also provides a comprehensive guide to practical radio, from LF to the GHz bands, for professionals and students.

Order: RSRCH **\$50.00**

RSGB Prefix Guide

By Fred Handscombe, G4BWP.

RSGB, 6th Ed., 2003. 48 pages.

This book is an excellent tool for the beginner and the experienced hand alike. Designed with a "lay flat" wire binding for ease of use the new "Prefix Guide" is a must for every shack.

Order: RSPFXG **\$13.50**

Visit Our Web Site
www.cq-amateur-radio.com

Name _____ Callsign _____

Street Address _____

City _____ State _____ Zip _____

Qty	Item #	Description	Price	Total Price
Shipping and Handling: US and Possessions - Add \$5.00 for the first book, \$2.50 for the second, and \$1 for each additional book. FREE SHIPPING ON ORDERS OVER \$75.00 (merchandise only). Foreign - Calculated by order weight and destination and added to your credit card charge. ALLOW 3 TO 4 WEEKS FOR DELIVERY			Total	

Method of payment Check Money Order Visa MasterCard Discover American Express

Credit Card No. _____ Expiration date _____



CQ Communications Inc., 25 Newbridge Rd., Hicksville, NY 11801/516-681-2922; Fax 516-681-2926

Order Toll-Free 800-853-9797

On The Cutting Edge, Looking To The Far Side

Using a technique called, "helioseismic holography," SOHO scientists are able to see the far side of the sun! This new way of seeing the sun is a result of many years of analysis and modeling. First noticed in 1962, patches of the surface of the sun oscillate up and down, with a typical period of about five minutes. These waves were a mystery for many years. The study of this phenomenon is "helioseismology," and the apparatus that views the far side of the sun is the Michelson-Doppler Imager (MDI).

In 1970, scientists identified the mysterious source of these oscillations and confirmed their discovery by 1975. The oscillations we see on the surface are due to sound waves generated and trapped inside the sun. Pressure fluctuations in the turbulent convective motions of the sun's interior cause sound waves, which last about five minutes. The pressure fluctuations, about the size of California, are like bubbles and are called "solar granulation." Solar sound waves are mostly trapped inside the

sun and refract away from the hot core and reflect back and forth between different parts of the photosphere.

The photosphere is the visible surface of the sun. Since the sun is a ball of gas, this is not a solid surface but actually a layer about 100 km thick. This layer is sort of like a layer in our own atmosphere, like the troposphere. The photosphere is very thin compared to the 700,000-km radius of the sun.

A number of features can be observed in the photosphere with a simple telescope. (*Note: Never look directly at the sun, including through a telescope. You should also use a good filter to reduce the intensity of sunlight to safely observable levels, as reflected sunlight may also cause damage to your eye.*) These photospheric features include the dark sunspots, the bright faculae (structures on the sun's surface that are slightly cooler or hotter than the surrounding photosphere), and granules. The flow of material in the photosphere may also be measured using the Doppler effect. These measurements reveal additional fea-

The Ap Index And Understanding Propagation Terminology

The Ap index, or Planetary A index, is a 24-hour averaging of the Planetary K index. The Planetary K index is an averaging of worldwide readings of earth's geomagnetic field. High indices ($K_p > 5$ or $A_p > 20$) means stormy conditions with an active geomagnetic field. The more active, the more unstable propagation is, with possible periods of total propagation fade-out. Especially around the higher latitudes and especially at the Polar Regions, where the geomagnetic field is weak, propagation may disappear completely. Extreme high indices may result in aurora propagation, with strongly degraded long distance propagation at all latitudes. Low indices result in relatively good propagation, especially noticeable around the higher latitudes, when trans-polar paths may open up. Maximum K-index is 9, and the A-index can exceed well over 100 during very severe storm conditions, with no maximum.

Classification of A-indices is as follows:

A0-A7 = quiet	A30-A49 = minor storm
A8-A15 = unsettled	A50-A99 = major storm
A16-A29 = active	A100-A400 = severe storm

Solar Flux (SF): This flux number is obtained from the amount of radiation on the 10.7-cm band (2800 MHz). It is closely related to the amount of ultraviolet radiation, which is needed to create the ionosphere. Solar Flux readings are more descriptive of daily conditions than the Sunspot Number. The higher the Solar Flux (and, therefore, the higher the Sunspot Number), the stronger the ionosphere becomes, supporting refraction of higher frequencies.

Ionosphere: A collection of ionized particles and electrons in the uppermost portion of the earth's atmosphere, which is formed by the interaction of the solar wind with the very thin air particles that have escaped earth's gravity. These ions are responsible for the reflection or bending of radio waves occurring between certain critical frequencies with these critical frequencies varying with the degree of

ionization. As a result, radio waves having frequencies higher than the Lowest Usable Frequency (LUF) but lower than the Maximum Usable Frequency (MUF) are propagated over large distances.

Sunspot Number (SSN): Sunspots are magnetic regions on the Sun with magnetic field strengths thousands of times stronger than the earth's magnetic field. Sunspots appear as dark spots on the surface of the Sun. Temperatures in the dark centers of sunspots drop to about 3700° K (compared to 5700° K for the surrounding photosphere). This difference in temperatures makes the spots appear darker than elsewhere. Sunspots typically last for several days, although very large ones may last for several weeks. They are seen to rotate around the sun, since they are on the surface, and the sun rotates fully every 27.5 days.

Sunspots usually occur in a group, with two sets of spots. One set will have positive or north magnetic field while the other set will have negative or south magnetic field. The field is strongest in the darker parts of the sunspots (called the "umbra"). The field is weaker and more horizontal in the lighter part (the "penumbra").

Galileo made the first European observations of sunspots in 1610. The Chinese and many other early civilizations have records of sunspots. Daily observations were started at the Zurich Observatory in 1749; continuous observations were begun in 1849.

The sunspot number is calculated by first counting the number of sunspot groups and then the number of individual sunspots. The "sunspot number" is then given by the sum of the number of individual sunspots and 10 times the number of groups. Since most sunspot groups have, on average, about 10 spots, this formula for counting sunspots gives reliable numbers even when the observing conditions are less than ideal and small spots are hard to see. Monthly averages (updated monthly) of the sunspot numbers show that the number of sunspots visible on the sun waxes and wanes with an approximate 11-year cycle.

For more information, see <http://prop.hfradio.org>.

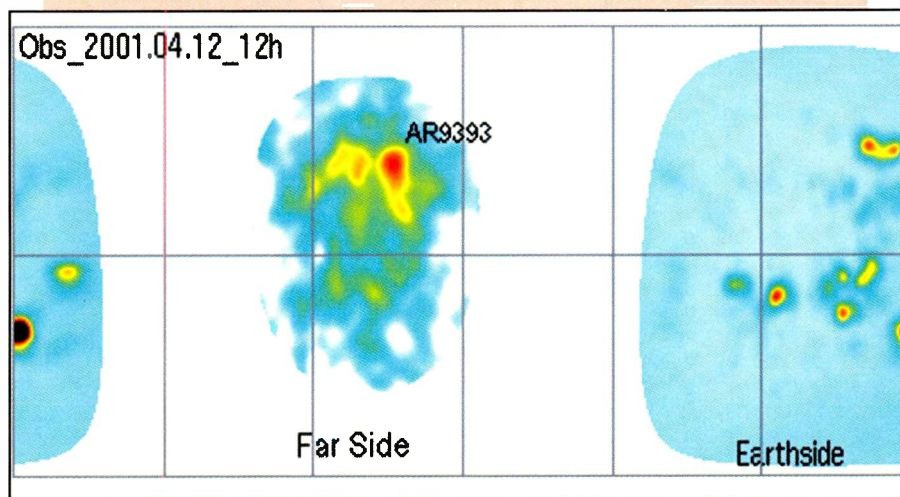

A holographic map captured April 12, 2001, showing the giant sunspot AR9393 on the back side of the sun a full week before it emerged into direct view over the sun's eastern limb. MDI holographic images reveal the earth-facing side of the sun 70 degrees from the disk center, and the far side of the sun 50 degrees from disk center. The false colors represent condensations of magnetic flux, or, sunspots. As a reference, check out the website at <http://soi.stanford.edu/data/farside/>.

tures, such as “supergranules,” large-scale flows, and a pattern of waves and oscillations—the helioseismic information we’re interested in.

After many years of careful observation and analysis, today’s helioseismologists use these sound waves, and the modes of vibration they produce, to probe the interior of the sun the same way that geologists use seismic waves from earthquakes to probe the inside of the earth. This technique of seeing the far side of the sun using helioseismic information results in the holography that gives propagation forecasters and scientists a view of what is coming around to the visible side. A full week or so before a group of sunspots rotate into the earth-facing side, we can detect the progress of old activity and detect new activity before it arrives.

Figure 1 is an example of a helioseismic holographic image. One site that shows the current helioseismic image is <http://spaceweather.com/>. For a detailed look at how helioseismology works, check out http://science.msfc.nasa.gov/ssl/pad/solar/p_modes.htm.

Geomagnetic Storms

I have received several e-mail messages over the last few years from people who are neither amateur radio operators nor shortwave radio hobbyists. It seems that

they’ve been finding a correlation between the planetary A Index (Ap) and the ability of racing pigeons to find their way around. When the Ap Index is high and the geomagnetic field is stormy, the pigeons are not able to navigate. They simply get lost and confused. This group of pigeon racers is using the Propagation eAlert service that I provide to help them plan when they should train or race their unique navigators. (You, too, may subscribe for free at <http://prop.hfradio.org/ealert/>.)

This year has been rough for the most part for all who depend on the geomagnetic field. This is because of the increase in coronal holes and the coronal hole mass ejections typical during the few years following each solar cycle maximum. For the rest of this year, amateur radio hobbyists and shortwave listeners will continue to be challenged by periods of very high storminess.

Current Solar Cycle 23 Progress

The Dominion Radio Astrophysical Observatory at Penticton, BC, Canada, reports a 10.7-centimeter observed monthly mean solar flux of 128 for July 2003, down a point from June. The 12-month smoothed 10.7-centimeter flux centered on January 2003 is 149, down several points from December 2002.

The Royal Observatory of Belgium, the world’s official keeper of sunspot records, reports an observed monthly mean sunspot number of 85 for July 2003, down from 77 for June. The 12-month running smoothed sunspot number centered on January 2003 is 81, one point down from December 2002. The sunspot low for the July 2003 was 28 on July 26. The sunspot high of 161 occurred on July 20. This range was wider, with a significantly higher peak, than June’s range of 38 to 116.

The observed monthly mean Ap index for July 2003 is 20, down four points from June’s 24, yet considerably higher than the Ap of 11 for July 2002. The 12-month smoothed Ap index centered on January 2003 is 18, up one point from December.

A smoothed sunspot level of 49 and a 10.7-centimeter solar flux of about 102 are predicted for November 2003. The geomagnetic planetary A Index (Ap) may decrease a bit during November, and certainly will through the winter season.

HF Propagation

Paths on 31 through 19 meters are becoming ever more reliable between North America and Europe in the morning, and between North America and Asia during the late afternoon hours. The strongest openings occur for a few hours after sunrise and during the sunset hours. Thirty-one and 25 meters will often remain open into many areas late into the night and will open early in the morning, especially when part of the propagation path moves through sunlit regions. Twenty-two and 19 may still offer nighttime paths, though these will become less reliable later in November.

Nineteen, 22, and 25 meters compete with 16 for the good daytime DX during November. They will open for DX just before sunrise and should remain open from all directions through out the day, with a peak in the afternoon. Nighttime conditions will favor openings from the south and tropical areas. Since the Southern Hemisphere has long daylight hours, DX paths on these bands from stations in the south will be common.

The all-season bands—31 and 25 meters—are crowded, and signals are usually very strong and steady. Twenty-five meters is expected to be an excellent band for medium distance (500 to 1,500 miles) reception during the daylight

Optimum Working Frequencies (MHz) - For November 2003 - Flux = 102, SSN = 49 - Created by NW7US

UTC	00	01	02	03	04	05	06	07	08	09	10	11	12	13	14	15	16	17	18	19	20	21	22	23	
TO/FROM US WEST COAST																									
CARIBBEAN	19	15	13	12	11	11	11	10	10	10	10	10	9	9	17	20	21	22	23	23	23	23	22	21	
NORTHERN SOUTH AMERICA	28	25	20	16	15	15	14	14	13	13	13	13	13	12	21	26	28	30	31	31	31	31	31	31	30
CENTRAL SOUTH AMERICA	27	24	17	16	15	15	14	14	14	13	13	13	13	13	22	26	29	30	31	31	32	31	31	29	
SOUTHERN SOUTH AMERICA	29	27	23	17	16	16	15	14	14	14	13	13	13	13	18	25	27	29	30	31	31	32	32	31	
WESTERN EUROPE	9	9	9	9	9	9	9	9	9	9	9	9	9	9	10	14	15	15	14	13	10	10	10	9	
EASTERN EUROPE	9	9	9	9	9	9	9	9	9	9	9	9	9	9	9	11	14	12	10	10	10	9	9	9	
EASTERN NORTH AMERICA	21	18	14	13	13	12	12	11	11	11	11	11	11	11	18	22	23	24	25	25	25	25	24	23	
CENTRAL NORTH AMERICA	13	12	10	8	7	7	6	6	6	6	6	6	6	6	6	11	12	13	13	14	14	14	14	13	
WESTERN NORTH AMERICA	7	6	6	4	4	3	3	3	3	3	3	3	3	3	3	4	6	6	7	7	7	7	7	7	
SOUTHERN NORTH AMERICA	21	20	16	13	12	12	11	11	10	10	10	10	10	10	13	19	21	22	23	24	24	24	23	23	
NORTHERN AFRICA	10	9	9	9	9	9	9	9	9	9	9	9	9	9	12	15	16	17	17	13	11	11	10	10	
CENTRAL AFRICA	12	11	10	10	10	9	9	9	9	9	9	9	9	9	11	14	16	17	17	14	13	13	12	12	
SOUTH AFRICA	19	15	13	12	12	12	11	11	11	11	11	10	10	18	20	22	23	23	24	24	23	22	21		
MIDDLE EAST	9	9	9	9	9	9	9	9	9	9	9	9	9	9	9	12	14	12	11	10	10	10	9		
JAPAN	19	19	18	17	15	11	11	10	10	10	9	9	9	9	9	9	9	9	9	9	9	9	15	17	19
CENTRAL ASIA	19	18	18	17	14	11	10	10	10	10	9	9	9	9	9	9	9	11	11	11	11	11	17	19	
INDIA	8	14	13	10	10	9	9	9	9	9	9	9	8	8	8	9	9	9	9	8	8	8	8	8	
THAILAND	18	18	17	16	14	11	10	10	10	9	9	9	9	9	9	9	12	12	12	11	11	11	11	15	
AUSTRALIA	27	28	29	27	23	17	16	15	15	14	14	13	13	13	13	13	13	17	16	16	18	21	23	25	
CHINA	17	17	17	15	13	11	10	10	10	9	9	9	9	9	9	9	9	9	9	9	9	9	9	14	
SOUTH PACIFIC	30	30	29	26	21	17	16	15	15	14	14	13	13	13	13	13	17	17	19	22	24	26	27	29	

UTC	00	01	02	03	04	05	06	07	08	09	10	11	12	13	14	15	16	17	18	19	20	21	22	23	
TO/FROM US MIDWEST																									
CARIBBEAN	21	15	14	13	13	12	12	12	11	11	11	11	11	20	23	25	26	27	27	27	27	26	25	24	
NORTHERN SOUTH AMERICA	24	20	17	16	15	14	14	13	13	12	12	12	12	20	23	26	28	29	29	30	30	29	28	27	
CENTRAL SOUTH AMERICA	25	18	17	16	15	15	14	14	14	13	13	13	13	24	26	28	29	30	31	32	32	31	30	28	
SOUTHERN SOUTH AMERICA	28	24	20	18	17	16	16	15	14	14	14	13	13	20	24	26	28	29	30	31	31	32	32	30	
WESTERN EUROPE	9	9	9	9	9	9	9	9	9	9	9	9	9	14	16	17	17	16	16	14	12	10	10	10	
EASTERN EUROPE	9	9	9	9	9	9	9	9	9	9	9	9	9	11	13	13	12	12	11	9	9	9	9	9	
EASTERN NORTH AMERICA	15	10	10	9	9	8	8	8	8	8	8	8	8	13	15	17	18	18	19	19	19	18	18	16	
CENTRAL NORTH AMERICA	7	6	4	4	4	4	4	3	3	3	3	3	3	6	7	8	8	8	8	8	8	8	8	8	
WESTERN NORTH AMERICA	13	12	10	8	7	7	7	6	6	6	6	6	6	6	11	12	13	14	14	14	14	14	14		
SOUTHERN NORTH AMERICA	15	13	9	9	8	8	8	7	7	7	7	7	7	7	13	15	16	16	17	17	17	17	16	16	
NORTHERN AFRICA	11	11	10	10	10	9	9	9	9	9	9	9	11	16	17	19	19	20	20	19	14	13	13	12	
CENTRAL AFRICA	11	11	10	10	10	9	9	9	9	9	9	9	11	15	17	18	19	19	19	14	14	13	12	12	
SOUTH AFRICA	19	16	15	15	14	14	14	13	13	13	13	13	19	25	28	29	30	31	31	31	30	28	25	23	
MIDDLE EAST	9	9	9	9	9	9	9	9	9	9	9	9	9	14	16	17	17	15	11	10	10	10	9		
JAPAN	18	17	15	11	11	10	10	10	9	9	9	9	9	9	9	9	9	9	9	9	9	14	17	18	
CENTRAL ASIA	17	16	14	11	10	10	10	9	9	9	9	9	9	9	9	10	12	11	11	11	11	11	15	18	
INDIA	8	8	8	8	8	8	8	8	8	8	8	8	8	8	8	8	8	8	8	8	8	8	8	8	
THAILAND	16	15	13	11	10	10	10	9	9	9	9	9	9	9	9	12	12	12	11	11	11	11	11		
AUSTRALIA	27	28	26	21	16	16	15	14	14	14	13	13	13	13	13	18	18	17	16	16	19	22	24	26	
CHINA	16	15	13	10	10	10	10	9	9	9	9	9	9	9	9	10	9	9	9	9	9	9	9	13	
SOUTH PACIFIC	30	28	25	18	17	16	15	15	14	14	13	13	13	13	13	18	17	17	20	23	25	27	28	29	

UTC	00	01	02	03	04	05	06	07	08	09	10	11	12	13	14	15	16	17	18	19	20	21	22	23	
TO/FROM US EAST COAST																									
CARIBBEAN	16	13	12	11	11	10	10	10	9	9	9	9	15	18	20	21	22	22	22	22	22	21	20	19	
NORTHERN SOUTH AMERICA	21	19	17	16	15	14	13	13	12	12	11	11	16	20	22	24	25	26	27	27	27	26	25	24	
CENTRAL SOUTH AMERICA	23	21	19	18	17	16	15	15	14	14	13	17	22	25	26	28	29	30	31	32	32	31	29	27	
SOUTHERN SOUTH AMERICA	26	23	21	20	18	17	16	16	15	14	14	14	20	23	25	26	28	29	30	31	31	32	31	29	
WESTERN EUROPE	9	9	9	9	8	8	8	8	8	8	8	13	16	17	18	18	18	17	16	15	13	10	10	9	
EASTERN EUROPE	9	9	9	9	9	9	9	9	9	9	9	11	15	15	15	15	14	14	13	10	10	9	9	9	
EASTERN NORTH AMERICA	6	5	4	4	4	4	4	4	4	4	3	6	7	8	9	9	9	9	9	9	9	8	7		
CENTRAL NORTH AMERICA	15	11	10	10	9	9	9	9	8	8	8	8	8	13	16	18	19	19	20	20	19	18	17		
WESTERN NORTH AMERICA	22	18	14	13	13	12	12	11	11	11	11	11	11	19	22	24	25	25	26	26	25	25	23		
SOUTHERN NORTH AMERICA	17	12	11	11	10	10	9	9	9	9	9	9	9	15	18	19	20	21	21	21	21	21	20	19	
NORTHERN AFRICA	12	12	11	11	11	11	11	11	11	11	11	19	22	24	25	25	26	24	23	20	14	14	13	12	
CENTRAL AFRICA	12	12	12	11	11	11	11	11	11	11	11	19	22	24	25	26	26	24	21	16	15	14	13	13	
SOUTH AFRICA	17	16	16	15	14	14	14	13	13	13	13	23	27	30	31	31	31	32	32	31	30	28	26	19	
MIDDLE EAST	11	10	10	10	9	9	9	9	9	9	9	14	17	19	20	20									

hours. Longer distance reception (up to 3,000 miles) should be possible for an hour or two after local sunrise, and again during the late afternoon and early evening. Heavy congestion will occur here since many international and domestic broadcasters make use of 25 meters. Thirty-one meters, the backbone of worldwide shortwave broadcasting, will provide medium-distance daytime reception ranging between 400 and 1,200 miles. During November, reception up to 2,500 miles is possible during the hours of darkness and until two to three hours after local sunrise. Thirty-one meters, too, is highly congested, making reception of weak exotic signals a bit more of a challenge.

Thirteen and 16 meters will be open during a fair number of days through November when flux levels remain above 100. Paths from Europe and the South Pacific as well as from Asia, at least during days of higher solar flux levels, are common, especially on 16 meters. Look for best conditions from Europe and the northeast before noon and from the rest of the world during the afternoon hours. Reception from the South Pacific, Australia, New Zealand, and the Far East should be possible well into the early evening. When flux levels fall below 120, though, these openings may be short.

Seventy-five through 120 meters are coming alive in late October. Throughout November, expect an improvement in nighttime DX conditions. Since the night is longer, and there is the seasonal decrease in the static levels, expect long-range DX on the low bands, starting close in right after sunset and extending farther as the night develops, with Europe possible in the late evening. DX paths will move farther west through the night. By morning, openings from Asia should be common.

Signals below 120 meters have improved, with the night-paths growing larger in the Northern Hemisphere. Seasonal static, which makes it difficult to hear weak DX signals, is still decreasing as we move into the depth of winter.

Aurora is still a possibility during November, as we are still in the peak years of the geomagnetic activity of this cycle. Those who are interested in long-range DX of VHF signals might be able to catch a few auroral openings during November.

Until next month, 73. ■

v.i.p.

spotlight *how you got started in radio*

Congratulations To Gene Copeland Of Malta, Montana!

Popular Communications invites you to submit, in about 300 words, how you got started in the communications hobby. Entries should be typewritten, or otherwise easily readable. If possible, your photo (no Polaroids, please) should be included.

Each month, we'll select one entry and publish it here. Submit your entry only once; we'll keep it on file. All submissions become the property of *Popular Communications*, and none will be acknowledged or returned. Entries will be selected taking into consideration the story they relate, and if it is especially interesting, unusual or even humorous. We reserve the right to edit all submitted material for length, grammar, and style.

The person whose entry is selected will receive a one-year gift subscription (or one-year subscription extension) to *Popular Communications*. Address all entries to: "V.I.P. Spotlight," *Popular Communications*, 25 Newbridge Road, Hicksville, NY 11801 or e-mail your entry to popularcom@aol.com, letting us know if you're sending photos. Please print your return address on the envelope

if using the postal mail system. Not doing so will delay your submission being processed. If you're e-mailing photos, please send them in a separate e-mail with your name in the "subject" line.

Our November Winner: Gene Copeland, KC7WWY

Pop'Comm reader Gene Copeland of Montana tells us,

I actually started in radio when I was five or six years old. We would go visit our aunt and uncle and the first place I would go was to see if my uncle was on the radio. He would ask me, "sounds like they're talking in a barrel of water, doesn't it?" I was always intrigued by radio. At the present time I have my uncle's last radio; before losing to cancer he gave me his Kenwood TS-520S. It's a great radio—100 watts output, barefoot.

I also own a 2-meter Kenwood TS-700SP all-mode, Alinco 144/440 dual-band FM, Alinco 6-meter FM, a CB SSB base station, a handheld scanner, a 1943 Howard military receiver, and numerous other radio accessories. I also work a few satellites.

Radio, what a wonderful hobby! Never boring! Hope to hear you on the air one day. ■

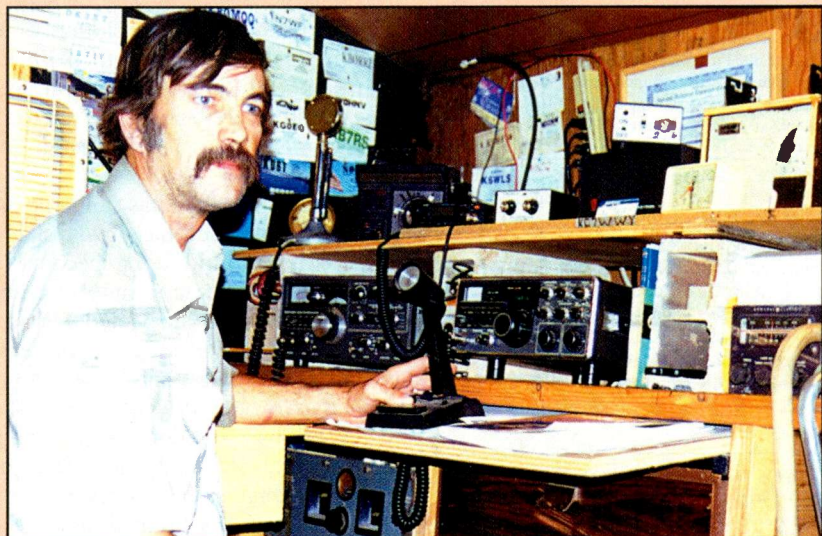

Here's Gene Copeland, KC7WWY, of Montana in his neat-looking shack.

our system works. (As I was always told in the Army, "that's the way it is.") Baloney. It's not that it *works*, really, but rather how it *doesn't* perform. Millions upon millions gets spent in the name of homeland security, a new federal department is created, and you and I get a little plastic whistle in our cereal box and a "Fight Terrorism" bumper sticker to toss at the guy with the box cutter and 45. Meanwhile, *you'll* be standing in line for a half-hour explaining your scanner or HT.

Now the bureaucracy adds a little something to their anti-terrorism program that is just one step short of the funny farm. Our Homeland Security Department will be testing a new program that will assign a security risk to airline passengers. You meet the criteria and you're a shoe-in, but if you look Osama bin Laden, share his birth date, or fit what I'm sure is some goofy federal profile, look out.

The Department, only after loud outcries from privacy advocates, decided to scale back the program so less personal information will be screened. Originally your credit history and medical information was going to be in the database, but

thankfully (and supposedly) it will not. As it currently stands, you'll have to provide your name, address, phone number, and birth date when traveling by air. No date for implementation has been announced, but this is definitely a hot issue.

Will it work? Aaah, yes, there's that operative word again, *work*. It will be implemented, but whether it's ultimately *effective* is anyone's guess, but my guess is that it's a waste of time. Obviously the government is curious about our travel plans and wants to build a database of where we've been so they might hypothesize where we might be going. So why not just ask us when we buy the ticket? It's about as effective.

Any terrorist worth his or her weight in laptops and boom boxes is going to travel the country on a more-or-less unlimited budget (probably partially funded by oil-rich nations we support), eat at McDonalds, and have a couple of credit cards. I'm also thinking that if your face matches the two forms of ID now required to board a plane, at least *one* of those IDs will have your name, address, and birth date. Maybe they want to compare to see if we're lying.

My encounter with security at Amsterdam International many years ago was a Kodak Moment: me in an Army "Class-A" uniform, luggage open, our clothes emptied and patted down, while the officer asked me countless questions about an old digital readout alarm clock I had rolled up in my socks. My handheld scanner wasn't on their mind, although they asked me to turn it on and open the battery compartment.

In the end we passed muster and the fellow politely escorted us to the gate and the doors closed. I can't help wondering if I had been in civilian clothes or was sporting a three-day growth if I'd have been stopped? But at least the folks overseas would always ask me to "turn on the scanner—I need to hear something and see it scan."

I suspect not much has fundamentally changed. Not much has *really* changed here, either. Could it be because our American bureaucracy is more concerned about violating a suspected terrorist's civil rights than they are about protecting your life and mine? That's just one reason why we—the *thinking* public—have to get serious about doing at least part of *their* jobs. It really isn't that difficult, and, in the final analysis, as history has proven over and over, it's the actions of *just a handful* of well-intentioned folks that effects change.

What does all this bureaucratic mess and limp functionality have to do with you and what can *you* do? Well, plenty. You see, *we're* at the cutting edge of security whether we like it or not. Our government even *partially* admits it; they actually like telling us that we're all in this long-term fight together and how it's everyone's responsibility to defeat terrorism. My question is, then: Uncle George, may we get refunded just a *little bit* of what all those new fancy government security agencies and their employees rake in? You know, the ones that are tasked with our protection? Talk about a sizeable refund!

In speaking of airline security, Sen. Charles Schumer (D-N.Y.), recently said, "They don't have enough money to do the job for homeland security...every time there's a problem in one place they pull money out of another."

While I usually agree with Schumer's outspoken, hard-hitting comments, I beg to differ with the good Senator. The Government has *plenty* of money, too much, in fact. They just don't know how—or don't care—to use it to the public's advantage. Certainly, wiser future generations will ponder why we couldn't see the writing on the wall.

The bottom line is this: If you're bringing along your HT, scanner, or portable shortwave radio on a flight, put them through the X-ray machine. You might even be asked to turn on the radio. Politely do so, with a minimal amount of fuss and explanation.

Personally, I wouldn't bring along that long, telescoping metal whip antenna; stick with the rubber duck and be happy. It might not be too smart to bring your latest print copy of Johnny's Military, Government, and Airport Frequency Database you plucked from the Internet.

You might also want to listen privately using headphones or an earpiece if you listen at *all* in the airport. I'm not one for relinquishing our right to listen, but remember, we're living in a time when evacuating an entire air terminal because a little old lady slipped through security and was never found (Chicago's Midway International as this is written)—possibly simply because she didn't hear the security officer telling her to stop—is commonplace. I'd err on the side of common sense.

Above all, if you see or hear something out of the ordinary, like a fellow in the rest room clipping wires or nervously trying to "repair" his laptop in the waiting area trust your gut that something is odd. Then, please tell Aunt Wilma. ■

readers' market

Advertising Rates for Readers' Mart: Non-commercial ads are 30 cents per word, including abbreviations and addresses; minimum charge \$6.00 per issue. Ads from firms offering commercial products or services are \$1.00 per word; minimum charge \$20.00 per issue. Boldface words are \$1.20 each (specify which words). Leading key words set in all caps at no additional charge. All ads *must be prepaid in full* at time of insertion; a 5% discount is offered for prepaid 6 time insertions. All ads must be typewritten double spaced.

Approval: All ad copy is subject to Publisher's approval and may be modified to eliminate references to equipment and practices which are either illegal or otherwise not within the spirit or coverage scope of the magazine.

Closing Date: The 10th day in the third month preceding date of publication. Because the advertisers and equipment contained in Readers' Market have not been investigated, the Publisher of *Popular Communications* cannot vouch for the merchandise listed therein. Direct all correspondence and ad copy to: Attention: Classified Dept., PC Readers' Market, 25 Newbridge Rd., Hicksville, NY 11801.

COMMUNICATIONS MONITORING ANTENNAS, HF/VHF/UHF Super Discone \$49.75, AntennaCraft Scantenna \$47.70, 30-1200 MHz. 4-12 dB Log Periodic \$69.50, 806-900 MHz. 13 dB 9 element Yagi \$74.00, MURS/GMRS Dual Band Base \$48.95. All prices **INCLUDE** Priority S&H&I. See these antennas plus many, many more for Amateur, Business, CB, and Monitoring radio, plus cellular phone antennas on the web at: www.antennawarehouse.com MC/Visa Order line 877-680-7818. To help maintain our low pricing, we do not print catalogs.

SELLING: The affordable **FUN** of antique radio is **BUILDING** one yourself. Reprints 1930's/1940's simple tube shortwave receivers plans. Free list. Bob Ryan, 1000 S. Gilbert Street, Apt. 132, Hemet, CA 92543-7065

ADVERTISERS' INDEX

Advertiser	Page Number	Website Address
AOR USA, Inc.	Cov. III	www.aorusa.com
Action Radio Network	53	www.ActionRadioNetwork.com
Antique Radio Classified	29	www.antiqueradio.com
Atomic Time, Inc.	9	www.atomictime.com
C. Crane Company	Cov. IV	www.ccrane.com
CQ Amateur Radio Calendar	49	www.cq-amateur-radio.com
CQ Amateur Radio Magazine	51	www.cq-amateur-radio.com
CQ Bookstore	31,65	www.cq-amateur-radio.com
CQ VHF Magazine	22	www.CQ-VHF.com
Computer Aided Technologies	43	www.scancat.com
Hollins Radio Data	23	www.policecall.com
ICOM America, Inc.	15	www.icomamerica.com
LT Sound	53	www.VocalEliminator.com/g.o/PC
Lee Electronics	19	www.LeesElect.com
Lentini Communications, Inc.	13	www.lentinicomm.com
MFJ Enterprises, Inc.	39	www.mfjenterprises.com
Maco	53	www.majestic-comm.com/maco
Monitoring Times	55	www.grove-ent.com
New Communications Solutions, LLC	19	www.ncsradio.com
Optoelectronics, Inc.	3	www.optoelectronics.com
Palomar Engineers	29	www.Palomar-Engineers.com
PowerPort	19,53	www.powerportstore.com
REACT International, Inc.	38	www.reactintl.org
RSGB Books	73	www.cq-amateur-radio.com
Radioworld, Inc.	29	www.radioworld.ca
Universal Radio, Inc.	1	www.universal-radio.com
W5YI Group, The	51	www.w5yi.org
Yaesu	Cov. II	www.vxstdusa.com

Reach this dynamic audience with your advertising message, contact Arnie Sposato at 516-681-2922, FAX 516-681-2926, or e-mail: PCAdvertising@aol.com.

If you enjoy radio communications you'll love....

POPULAR COMMUNICATIONS

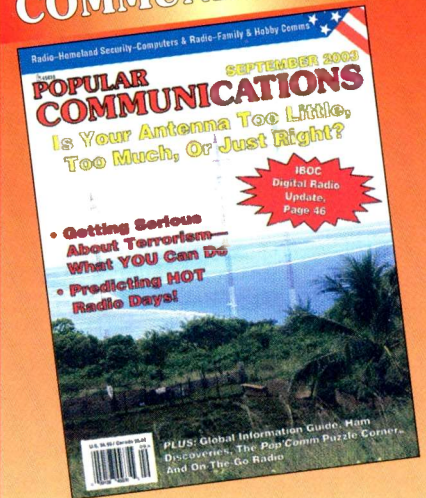

The World's most authoritative monthly magazine for Shortwave Listening and Scanner Monitoring. Read by more active listeners world-wide.

SUBSCRIBE TODAY!

POPULAR COMMUNICATIONS Ph: 516-681-2922

25 Newbridge Road, Hickville, NY 11801

SAVE UP TO 58%

Get fast home delivery of *Popular Communications* and save \$30.93 a year over the newsstand price. Save even more on 2 or 3 year subs.

- 1 year - 12 issues **\$28.95**
(Save \$30.93)
- 2 years - 24 issues **\$51.95**
(Save \$67.81)
- 3 years - 36 issues **\$74.95**
(Save \$104.69)

Canada/Mexico—One year \$38.95, two years \$71.95, three years \$104.95; Foreign Air Post—one year \$48.95, two years \$91.95, three years \$134.95.

Payable in US dollars only

Name _____
Street _____
City _____
State _____ Zip _____
Bill to Mastercard • VISA
• AMEX • Discover

Account number: _____

Exp. date: _____
Note: Allow 6-8 weeks for delivery of first issue.

FAX 516-681-2926



Check out our Web site at:
www.popular-communications.com

connection radio communications humor

Bill Flies Off The Handle—To Dallas

Hello again friends of lunacy. It's good to see that most of you haven't been locked up for reading this column (but really, at least *some* of you should *buy* the magazine instead of reading it here in the store).

With the increased security concerns at airports and on commercial airplanes, I've had more opportunities for silliness (but, at the same time, more chances to be warned that security is no joking matter). On a recent trip to Dallas from our nation's capital, I was careful to carry only those things considered sufficiently innocuous to pass through security with no problems at all. I packed all my pointy and dangerous harmonica repair tools in my checked baggage and made certain to tell the x-ray person (who kept nodding his head and acknowledging that the metal objects were harmonica repair tools and were NOT implements of destruction. He continued to mumble and back away from me, smiling. I expected him to bring me an order of fries and a medium diet coke from behind the x-ray machine.

My carry-on luggage consisted of about 17 chromatic harmonicas and a CD player, headset, and a little FM transmitter designed to transmit the output of the CD player to any nearby FM radio. I didn't intend to use the transmitter in flight, but I had forgotten to pack it and it was small.

Thirteen of the harmonicas were packed in a pistol case. That was not a good thing. And they looked amazingly like pistol clips if the observer happened to be paranoid and ill-trained.

When I approached the carry-on x-ray machine, an agent tossed a plastic box toward my feet. I put my shoes in it. He then told me it was for the drink I was carrying. Oh. I put the shoes back on, put the drink in the container and sent it through the x-ray machine.

I laid the pistol case down on the belt. "These are harmonicas," I told him.

"What?" he asked.

"Harmonicas," I said. "Chromatic harmonicas. Thirteen of them. And here's another. And here are three more."

"What are you doing with all the harmonicas?" he asked.

"Carrying them." I said. He had crossed the line, and I let him know that I knew it.

"Let's take a look at them," he said, toting the lot of them to the special table set up for just such special items.

"Would you like to open the case, or should I?" I asked.

"Go ahead."

I opened the case, slowly. They were a beautiful sight, all chromed and gleaming.

"Can you play them?" he asked?

"Yes."

"Go Ahead."

"All of them?"

"No, just two or three."

I played a few notes on about three of them and he told me that was fine and that I could proceed to the gate. Even though there was an international harmonica convention in Dallas, he had obviously not dealt with any other attendees so far.

On the plane, the noise level was such that if I had decided to

play while we flew, only those very close to me would have heard me, and I couldn't have heard myself all that well and it probably would have just annoyed the passengers nearby, so I worked on some crossword puzzles.

Two rows ahead of me was a woman with the world's shrillest voice. I have no idea what she said, but about every third word loosened the buckle on my seat belt. It's hard to compare her to any known person. Bobcat Goldthwaite, maybe, on a really bad rant, or Selma Diamond if she spilled hot coffee in her lap, maybe. Oooh—how about Truman Capote hitting his thumb with a hammer!

Anyway the sound was the worst I'd heard in a long time, and I wanted it to stop, but I couldn't just say, "Lady, would you please stop talking? Your voice is really irritating!"

So I've got this miniature harmonica, only four holes, about an inch long and it fits right inside my mouth. If I play a note just right—beep beep—it sounds just like something the pilot sends over the loudspeaker before an announcement, but only two or three people can hear it, including Ms. Vulture-Voice.

So each time she squawks, I beep.

She stops. Her head whips around, looking for the source of the sound, and of course, there is none.

The person directly in front of me either doesn't care, is too bashful to look, or can't hear that particular frequency. The man next to me is laughing into his sleeve.

She squawks again. I beep again. She stops and looks again. Nothing. She whispers to her friend. I like the whispering. They whisper for a while, then sit, facing forward.

She looks at him, looks back, past me, squawks, I beep (she can't tell it's coming from me). She looks past me even more intently. She looks ahead, quietly. The man next to me does not make eye contact, but is making snickering noises into his magazine, which is now held close to his face.

She squawks, I beep, she rings for the flight attendant. She discusses what I assume is the beeping with the flight attendant, who looks aft, past me and shrugs, pats the Vulture-Woman on the shoulder and leaves, then returns with a complimentary headset, a pillow, and a blanket. The magazine next to me is shaking violently.

The remainder of the trip is quiet. And the convention was lots of fun! ■

**Solution to
Puzzle Corner
on page 57**

P	N	P		Y	A	G	I		Y	I	P		
A	T	A		N	T	S	B		R	O	A	M	
C	S	P		A	T	O	M		A	T	I	S	
K	C	A	L	B					L	E	A	R	N
				A	L	B		H	N	L			
S	K	Y	W	A	L	K	E	R		F	I	N	
M	T	R			A	F	C			B	C	B	
A	B	T		S	C	I	T	S	U	O	C	A	
				W	H	K		O	H	M			
X	E	Z	I	B				A	C	A	R	S	
O	P	E	R		C	H	A	D		B	A	H	
R	I	P	E		H	I	L	O		E	C	U	
		C	P	S		S	P	E	W		X	E	T

AOR SDU5600 Spectrum Display Unit

Spectrum Display Just Got More Interesting!



*With sampling at up to six times per second,
you're quickly aware of new active frequencies.*

*The "waterfall display" function is a new
convenience, along with a host of menu
driven selections and features.*

The AOR SDU5600 is the "next generation" in spectrum display units. Using a five-inch TFT color display, DSP and FFT (Fast Fourier Transform), faster sampling rates and color imaging, the SDU5600 opens the door to new possibilities and applications.

Enjoy full control of compatible AOR receivers. The 10.7 MHz input may be compatible with receivers from other manufacturers as well. PC control is also present, as is highly accurate frequency management.

AOR SDU5600

- High resolution 5 inch color TFT display
- Built-in "waterfall" display function
- Now features FFT signal analysis
- DSP
- Uses 10.7 MHz IF input frequency
- Wide input level range:
0 ~ -90 dBm
- High dynamic range, 60 dB
- Fully interactive with AOR AR5000 models, AR8600, AR-ONE
- 10 MHz bandwidth (± 5 MHz from center frequency)
- Samples up to 6x per second
- Four frequency resolutions:
4, 32, 64, 128 KHz
- Image output to your PC
- Bus signal can be saved to memory
- Graphic display and statistical (text) data
- Menu driven operation
- Two RS-232C ports for receiver and computer control
- Easy to operate



Authority On Radio
Communications

AOR U.S.A., Inc.
20655 S. Western Ave., Suite 112, Torrance, CA 9C501, USA
Tel: 310-787-8615 Fax: 310-787-8615
info@aorusa.com <http://www.aorusa.com>

Specifications subject to change without notice or obligation.

**The Serious Choice in
Advanced Technology
Receivers™**

Just Listen

Sangean ATS 505p

*Most Features & Best Performance
For The Price!*

- All Band SW Coverage
- SSB Listening
- 45 Memories
- Stereo thru Headphones
- SW Antenna Jack
- Dual Time Clock/Alarm
- Lighted LCD Display
- Case, Earbuds, SW Ant., AC Adapter

\$129⁹⁵



Sangean ATS 909

*The Ultimate Features & Performance
In A Portable Shortwave Receiver!*

- 306 Memories
- Upper & Lower SSB
- 42 World Times
- RDS
- Stereo thru Headphones
- SW Antenna Jack
- Dual Time Clock/Alarm
- Lighted LCD Display
- Case, Earbuds, SW Ant., AC Adapter

\$259⁹⁵



CCRadioplus

The Best AM Radio Made Today!

- ★ Programmable Station Timer
- ★ INPUT/OUTPUT Jacks
- ★ Signal Strength Meter
- AM, FM, TV Audio, Weather Band + Alert
- Built-in 6V DC Input Jack & Charging Circuit
- 6V Output Jack
- Audio Shaped for Human Voice
- 5 Memories Per Band
- Rotary Tuning Knob with 1kHz Tuning
- Lighted Digital Display

\$164⁹⁵



Call 800-522-8863 To Receive Our **FREE** CATALOG #14R!

SANGEAN

AMERICA, INC.
www.sangean.com

FREE
US Shipping
On Orders
Over \$25

C. CRANE
COMPANY, INC.

800-522-8863
ccrane.com